

MODELS VC-6025/VC-6045

**DIGITAL STORAGE
OSCILLOSCOPE**

OPERATION MANUAL

 **Hitachi Denshi, Ltd.**

MODELS VC-6025/6045
DIGITAL STORAGE OSCILLOSCOPES

OPERATION MANUAL

Hitachi Denshi, Ltd.

WARRANTY

This Hitachi Denshi, Ltd. product is warranted against defects in workmanship and materials. If any failure, resulting from a defect in either workmanship or material shall occur under normal use within THREE YEARS from the original date of purchase, such failure shall be corrected free of charge to the original purchaser by repair or, at Hitachi Denshi's sole option, replacement of the defective part or parts. No charge shall be made for labor or services performed during said THREE YEARS period providing the defective product is brought or sent prepaid to our Authorized Service Station. Hitachi Denshi, Ltd. will either repair or at its sole option, replace any part except for fuses, probes, lamps, batteries and other optional materials which are defective in either workmanship or material under normal and proper use.

This warranty does not cover equipment which has been tampered with in any way, or to damage caused by accident, negligence, alteration, or misapplication.

This product must be returned transportation prepaid, properly packed and insured. Hitachi Denshi, Ltd. bears transportation cost of the repaired product back to the purchaser. This warranty applies only to the original purchaser.

NO OTHER WARRANTIES ARE EXPRESSED OR IMPLIED. HITACHI DENSHI, LTD. IS NOT LIABLE FOR CONSEQUENTIAL DAMAGES.

NOTES FOR A SAFETY OPERATION

Before operating the instrument, be sure to check the following items.

(1) Terms in this manual

WARNING: Indicates a possible injury to a body or danger to life if care is not taken as described.

CAUTION: Indicates possible damage to the instrument or other equipment if care is not taken as described.

(2) Symbols

DANGER: Indicates the part which may cause an injury to a body or danger to life.

 **DANGER:** Indicates the high voltage part in the oscilloscope.

 **CAUTION:** Indicates to read the applicable items in this manual.

 : Protective earth terminal.

(3) Notes for operation

① Connection with the AC power source

The instrument is provided with the protective earth terminal and the three-line power cord and plug to be connected to the AC power source. The lead of the protective earth terminal is connected to the metallic part of the instrument.

Be sure to plug the power cord into an AC outlet provided with a protective earth terminal to avoid the risk of electric shock.

② Replacement of fuse

Use only specified fuses.

The instrument is protected by a 2A fuse on the primary side of the power supply.

When this fuse is blown out, contact your nearest Hitachi Denshi representative. Do not try to use any fuse other than the specified ones.

Otherwise, further damage may occur and this could be dangerous.

(IMPORTANT: Use only the fuse of same size and rating as specified.)

	Shape (Diameter x length) mm	Type
2 A	5.2 x 20	EAK-2A

- ③ Operation in gas
Do not use the oscilloscope in combustible gas or vapor to avoid possible explosion.
- ④ POWER switch
Before plugging in the AC cord, be sure to check that the POWER switch is set to OFF for protection of the instrument.
- ⑤ Removal of the chassis
To avoid the risk of electric shock, do not remove the chassis by yourself. Contact your nearest Hitachi Denshi representative.

NOTE

- o The instrument operates normally with the 90 to 250 V line voltage. If the line voltage is out of the above range (especially lower voltage), the normal operation may not be restored even after the correct line voltage is applied. Use the instrument within the specified line voltage. If an abnormal operation occurs, check the line voltage, turn off the power for a short time, and then turn it back on.

WARNING:

Do not remove the chassis cover since a high voltage presents inside the instrument. When parts inside the instrument need to be adjusted or replaced, contact your nearest Hitachi Denshi representative.

- o When the power is turned on, the built-in microprocessor automatically calibrates the time base and diagnoses the sweep circuit operation. After the calibration, the time base settings are initialized.

The displays "CALIBRATION" and "COMPLETED" appear to show the normal calibration and sweep circuit operation. If other displays such as "CALIBRATION FAILED AT CYCLE CKT" appear and the display remains even when the power is turned off and on, contact your nearest Hitachi Denshi representative.

NOTES:

a) It will take approximately twenty seconds until the automatic diagnoses are completed after the power is turned on.

b) When the power switch is turned on after storage at a low temperature, it takes some time before the circuit operation becomes stable.

If the "FAILED" display appears while the power is on, keep the power-on state for several minutes. Turn off the power, then turn it back on, and check that the "COMPLETED" display appears.

- c) The built-in microprocessor may misoperate when turning the power switch on/off rapidly. Avoid rapid toggling of the power switch and allow three seconds or more for toggling.
- d) In case of the storage mode, the intensities of both the waveform and readout (characters) are changed simultaneously by the INTEN control. When the mode is changed to the storage mode with the intensity of waveform dark, the storage waveform and readout may become dark. In this case, turn the INTEN control clockwise to increase the intensity.
- e) The trace in the real-time mode or the storage mode may fluctuate slightly until the instrument is warmed after power up. It takes about 15 or 20 minutes until a stable measurement is ensured.
An error between the trace in the real-time mode and that in the storage mode may occur. (Less than 0.5 div approx.)
- f) Though the waveform is aligned with the graticule on the CRT in the storage mode, they may be deviated when plotted by the plotter. (Less than 0.5 div approx.)

CONTENTS

1. FEATURES	1
2. COMPOSITION	2
3. PRECAUTIONS	3
4. OPERATION PANEL	8
5. PANEL DESCRIPTION	10
5.1 Front Panel Section A	10
(1) Power and CRT	10
(2) Vertical deflection system	11
(3) Horizontal deflection system	14
(4) Trigger system	19
(5) Miscellaneous	22
5.2 Front Panel Section B	22
5.3 Rear Panel	23
6. HOW TO PRODUCE THE TRACE	25
7. METHOD FOR CONNECTING SIGNALS	27
8. BASIC OPERATIONS AND MEASUREMENT PROCEDURES	31
8.1 Data Display	31
(1) REAL TIME mode display	31
(2) STORAGE mode display	34
8.2 REAL TIME Mode	38
(1) Normal sweep display	38
(2) In the case of measuring a single waveform	39
(3) In the case of measuring two waveforms	40
(4) In the case of measuring a waveform in the X-Y mode	40
8.3 Digital Storage Functions	41
(1) Normal storage mode (NORM)	41
(2) Equivalent sampling mode (EQUIV)	41
(3) ROLL mode	42
(4) SINGLE mode	43
(5) HOLD mode	45

(6) SAVE operation (SAVE)	45
(7) Display of the save memory (RECALL)	45
(8) Output to the X-Y plotter (PLOT)	46
(9) Horizontal magnifying display (Magnification of time axis)	46
(10) Memory back-up function	47
(11) MENU mode	47
(12) Menu display in the modes other than MENU	50
(13) DLY operation	51
8.4 General Measurement	52
(1) Voltage measurement	52
(2) Time and frequency measurement	54
(3) How to trigger	56
(4) Measurement of the waveform before the trigger point (PRETRIGGER)	62
(5) Operation of the AUTO range function	63
(6) Operating procedure of the delayed sweep	64
(7) Measurement of single shot phenomena	68
(8) Operation of the BW LIMIT function (only valid for a trigger signal in the STORAGE mode)	69
(9) System reset	69
9. DIGITAL PLOT OUTPUT TO THE X-Y PLOTTER	70
9.1 Applicable X-Y Plotter	70
9.2 Specifications of Plot	70
9.3 Connection	75
9.4 Setting	75
(1) Plot mode	76
(2) Communication mode	77
9.5 Operation	79
9.6 RS-232C Interface	79
9.7 Major Causes of Troubles	80

10.	RS-232C	81
10.1	General	81
10.2	Specifications	81
10.3	Connector Pin Arrangement and Signal Description...	81
10.4	Connection	83
10.5	Operating Functions and Function Commands	84
	(1) Panel setting	84
	(2) Operating functions	85
10.6	Format of Transfer Data	89
	(1) Transmitting format of the waveform data	89
	(2) Receiving format of the waveform data	89
	(3) Transmitting and receiving format of measuring condition data	90
	(4) Transmitting format of parameters	90
10.7	Delimiter	98
10.8	Processing of Abnormal Operation	98
10.9	Connection of the RS-232C Interrace Cable and the Activation of the Instrument	99
10.10	Creation of Programs for Data Transfer	99
10.11	Major Causes of Abnormal Data Transfer	99
10.12	Programming Example	101
	(1) Program example 1 "S1" command	101
	(2) Program exmample 2 "TM" command	102
	(3) Program exmample 3 "Ri" command	102
	(4) Program exmample 4 "R0" command	103
	(5) Program exmample 5 "Wi" command	103
	(6) Program exmample 6 "W0" command	105
	(7) Program exmample 7 "E1", "E2", "E3", "G1", "G2", and "G3" commands	106
11.	SPECIFICATIONS	108

1. FEATURES

The Hitachi VC-6025, and VC-6045 are high-speed digital storage oscilloscopes provided with a high-speed A/D converter for each channel to enable the measurement, memory, and analysis of high-speed phenomena.

(1) High speed and wide bandwidth

A high-speed A/D converter is provided for each channel, and the input signal can be sampled at the following rates.

If the signal has a complete repetition, the signal of up to 100 MHz (50 MHz for the VC-6025) can be stored. Further this oscilloscope can be used as a normal 100 MHz (50 MHz for the VC-6025) real-time oscilloscope.

Model	Maximum sampling rate
VC-6045	40 Msps (at the one-channel sampling)
	40 Msps (at the two-channel alternate sampling)
VC-6025	20 Msps (at the two-channel alternate sampling)

(2) Memory of waveforms (save function)

Two 1 kilo-word save memories are provided, and up to two sets of the stored waveform can be saved.

The saved waveform is retained up to approximately 48 hours after the power is turned off, so that it is convenient to compare waveforms at a different place.

(3) Multiple functions

Multiple functions to analyze signals are provided.

- o Roll mode function: Facilitates the measurement of a low-speed signal.

- o Average function: Removes a noise component from the signal including random noises.
- o Smoothing function

(4) External interface functions

Various output functions are built in to analyze and record storage data.

- o RS-232C interface

Digital data is output to a personal computer, etc.

- o Digital plot function: A hard copy of the display on the CRT is directly obtained by the X-Y plotter via the RS-232C.

(5) CRT readout and cursor measurement functions

The operation and the measurement can be made quickly.

- o CRT readout function: Displays the characters of the setting information of the operation panel on the CRT.

- o Cursor measurement

function:

Displays the voltage difference (ΔV), the time difference (ΔT), and the frequency ($1/\Delta T$) between cursors alphanumerically.

2. COMPOSITION

(1) Oscilloscope	1 unit
(2) Accessories	
Probes, AT-10AP 1.5	2 pcs.
Fuse, 2 A (A spare fuse is provided in the fuse holder of the instrument)	1 pc.
Operation manual	1 copy
AC power cord, 3-conductor	1 pc.

3. PRECAUTIONS

Installation

- * Avoid installing the instrument in an extremely hot or cold place.
 - o Avoid placing the instrument in a place exposed directly to sunlight for a long time, in a car in mid-summer, or near a room heating device.
 - o The maximum operating ambient temperature is 40°C.

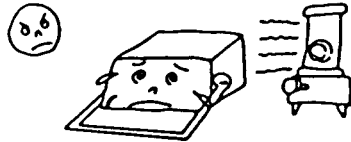

- * Do not use the instrument outdoors for a long time on a cold winter day. The operating ambient temperature is 0°C or more.

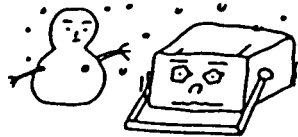

- * Avoid moving the instrument from a hot place to a cold place and vice versa, or condensation may form inside the instrument.

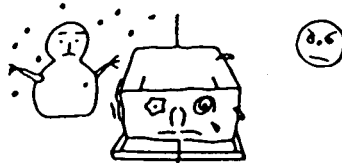

- * Keep the instrument away from damp air, water, and dust. Unexpected trouble may be caused when the instrument is placed in a damp or dusty place. The operating ambient humidity is 45 to 85%. Do not place a liquid-filled container on the instrument. An accidental intrusion of liquid may also cause troubles.



- * Do not place or use the instrument in a place subject to vibration.

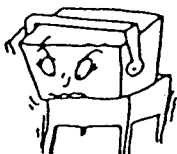

- * Do not place the instrument near a magnet or a magnetic body. An oscilloscope uses electron beams. Therefore, do not bring a magnet close to the instrument or do not use the instrument near an equipment generating strong magnetic force.

Operating considerations

- * Do not put a heavy object on the instrument.
- * Do not block ventilation holes.

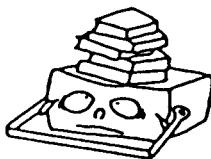

- * Do not apply a heavy shock to the instrument.



- * Do not insert a wire, pin, etc. through ventilation holes.



* Do not drag the instrument with a probe connected.

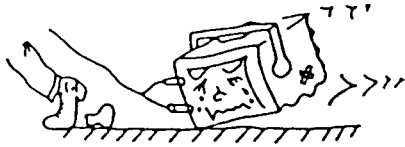

* Do not leave a hot soldering iron on or around the cabinet or the screen.

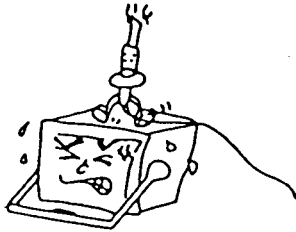

* Do not try to turn the instrument upside down. Otherwise, knobs may be broken.

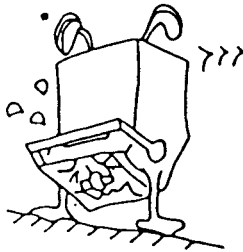

* Do not use the instrument upright, leaving cables connected to terminals or connectors on the rear panel. Otherwise, the cables may be damaged.

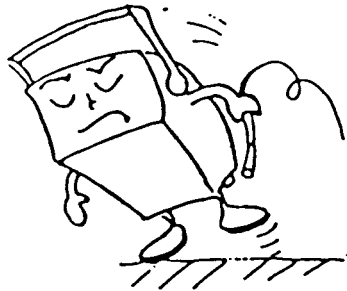

When not in use

When not in use, put the dust cover on the instrument.

Handle

Press in both pivot points of the handle and turn to the desired position.



Care

- * Removal of stain from the case
 - o When the outside of the case is stained, wipe it lightly using a neutral detergent and then clean the surface with a dry cloth.
- * Never use a volatile agent such as benzine and thinner.
 - o When the panel surface is stained, remove the stain with a clean, soft cloth. When heavy stains are present, first use a diluted detergent or alcohol and then clean with a dry cloth.



Maintenance

- (1) Use and store the instrument carefully to avoid damage to built-in precise components.
- (2) Clean the scale plate from time to time with a clean soft cloth.
- (3) The recommended ambient condition is 20°C, 65%.

Calibration interval

To maintain the instrument accuracy, perform the calibration after each 1000 hours of operation, or every six months if used infrequently.

Operating precautions

* Check the line voltage.

The operating voltage range of this instrument is 90 to 250 V AC. Check the line voltage without fail before turning on the power switch.

* Do not increase the brightness too much.

Do not increase the brightness of the spot and trace too much. Your eyes may be tired and the phosphor screen of the CRT may be burnt.

* Do not apply an excessive voltage.

The maximum input voltages of connectors and probe are as follows.

INPUT direct	400 V (DC + AC peak max. 1 kHz)
When X 10 probe is used	500 V (DC + AC peak max. 1 kHz)
EXT BLANKING	30 V (DC + AC peak)

CAUTION:

Never apply a voltage higher than specified to avoid possible damage to the instrument.

4. OPERATION PANEL

The digital storage oscilloscope is provided with the real time oscilloscope function and the digital storage function. The front panel is designed to offer ease of operation, and the panel is composed of the Section A for setting of measurement conditions and of the Section B for setting of operation modes.

When the REAL TIME mode is selected (Green STORAGE LED goes off), the instrument functions as a real time oscilloscope. This mode is called the REAL TIME mode.

When the STORAGE mode is selected (Green LED lights or blinks), the instrument functions as a digital storage oscilloscope. This mode is called the STORAGE mode.

Refer to Item 5.2 for the operation mode selection.

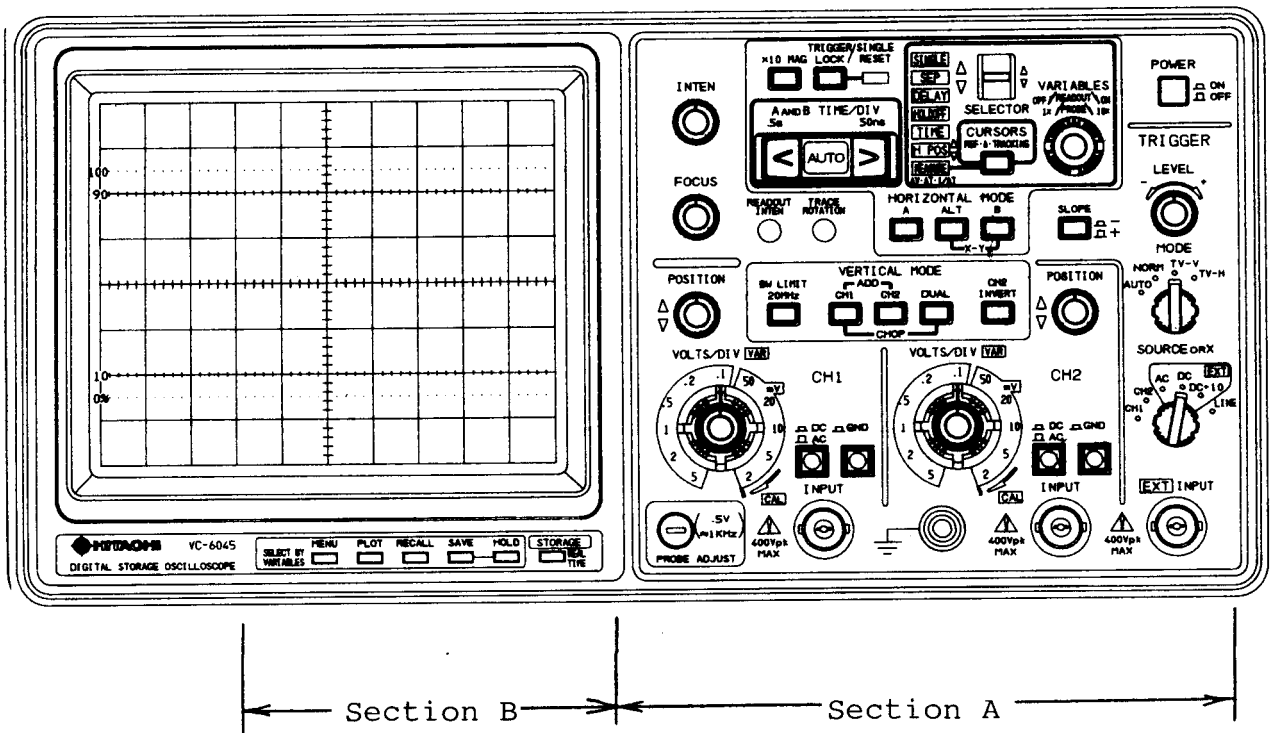

Fig. 4-1 (a) Front View (VC-6045)

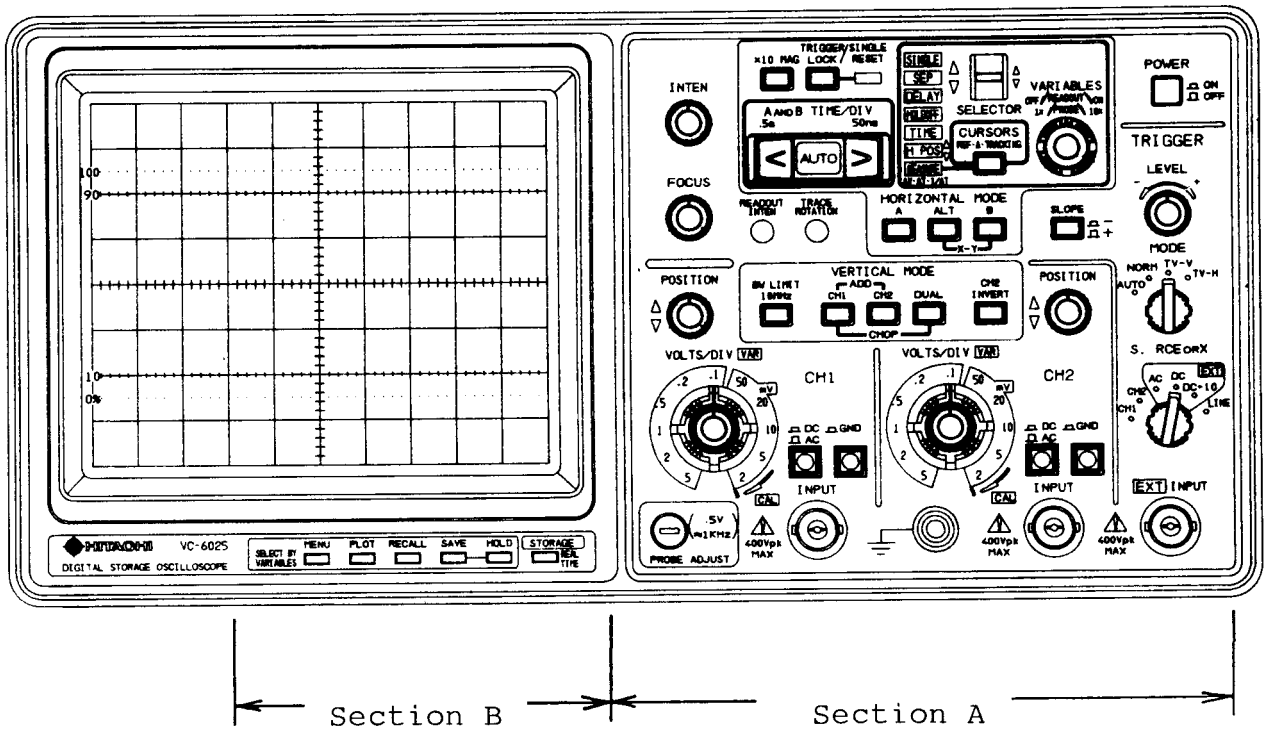

Fig. 4-1 (b) Front View (VC-6025)

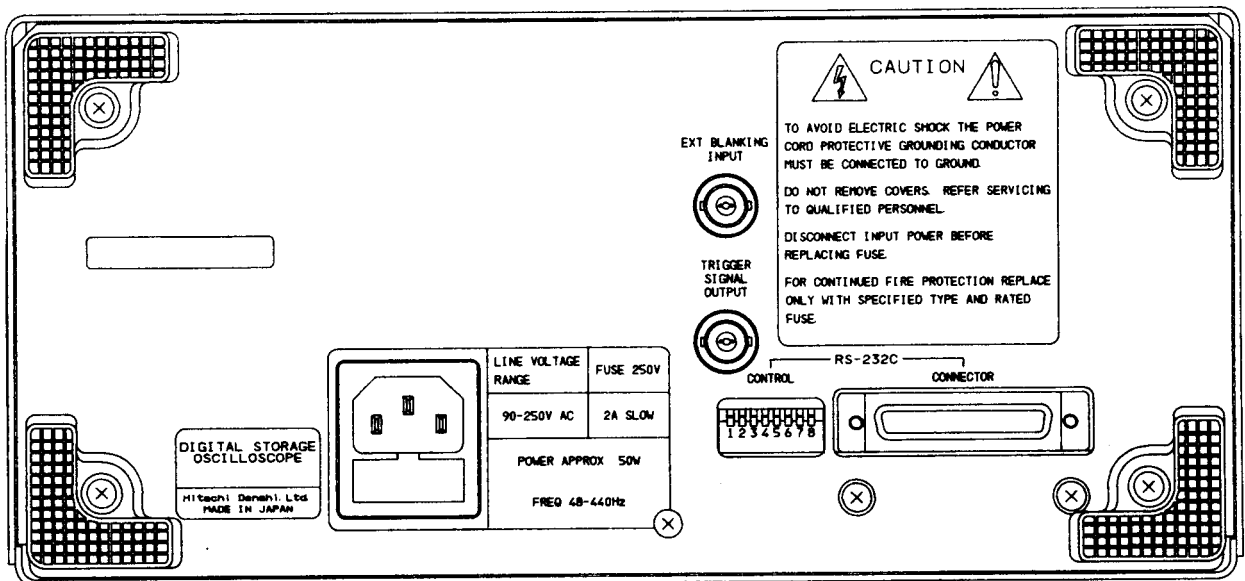

Fig. 4-1 (c) Rear View (VC-6025/6045)

5. PANEL DESCRIPTION

5.1 Front Panel Section A

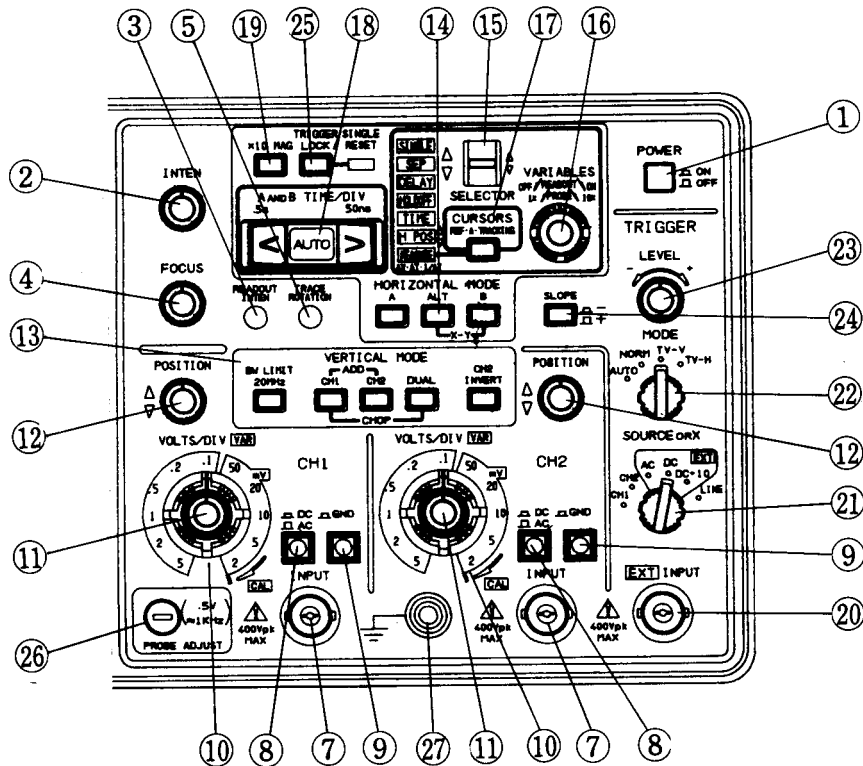

Fig. 5-1 Front Panel A section

(1) Power and CRT

① POWER switch

Power is ON in the pressed mode (), and OFF in the released mode ().

② INTEN control

A clockwise rotation increases the brightness of the waveform.

In the STORAGE mode, the brightness of the waveform and readout changes.

③ **READOUT INTEN control (screwdriver adjustment)**

A clockwise rotation increases the brightness of the readout. (REAL TIME mode only)

In the STORAGE mode, the brightness of the readout changes.

④ **FOCUS control**

After obtaining an appropriate brightness by the INTEN control, adjust the FOCUS control until the trace has best definition. Though the focus is corrected automatically when the INTEN control is rotated, adjust the FOCUS control if necessary.

⑤ **TRACE ROTATION control (screwdriver adjustment)**

This control corrects the displacement of trace caused by external magnetic fields. Align the trace with the horizon graticule line with this control.

(2) Vertical deflection system

⚠ ⑦ **INPUT connectors**

BNC connectors for CH1 and CH2 inputs.

⑧ **AC-DC switch**

When pressed in () , the mode is set to the DC coupling.

When pulled out () , the mode is set to the AC coupling.

AC: Input signal is capacitively coupled to the vertical amplifier. The DC component of the input signal is blocked.

DC: All frequency components of the input signal are coupled to the vertical deflection systems.

9 GND switch

This is an input coupling select switch.

The input of the vertical amplifier is grounded in the pressed mode ().

10 VOLTS/DIV switch

This is a step attenuator which selects the sensitivity.

Set to an appropriate range according to the incoming signal level.

11 VAR controls

* These controls provide a continuous variable vertical deflection factor.

Attenuation of down to 1/2.5 is obtained by turning in a counterclockwise direction.

* These controls are useful when comparing two waveforms or when measuring the rise time of a square waveform.

* Normally set to the CAL position.

12 POSITION control

This is a control which adjusts the vertical position of the trace.

Clockwise rotation moves a trace upward, while counterclockwise rotation moves it downward.

NOTE:

In the CH2 INVERT ON mode, the above operation is reversed.

13 VERTICAL MODE switch

This switch selects the operation mode of the vertical system.

CH1: The signal applied to CH1 is displayed.

CH2: Only the signal applied to CH2 is displayed.

DUAL: The signals applied to CH1 and CH2 are displayed as a dual trace.

The display in the REAL TIME mode is automatically selected by the TIME/DIV switch setting. When the TIME/DIV switch is set to 5 ms/DIV or slower, the CHOP mode is obtained. When the switch is set to 2 ms/DIV or faster range, the ALTERNATE mode is obtained.

In the STORAGE mode, each of the signals applied to CH1 and CH2 is sampled at the same timing (CHOP operation at the slower range than 1 ms/DIV and ALTERNATE operation at the faster range than 0.5 ms/DIV), and the stored waveforms of the dual trace are displayed.

CHOP: When CH1 and DUAL are pressed simultaneously, this mode is set.

When this mode is selected in the REAL TIME mode, the CHOP mode is selected even if the sweep range is set to the faster range. Input signals applied to CH1 and CH2 are switched at approximately 250 kHz regardless of the sweep, and displayed on the CRT. This mode is used in a faster range when it is required to measure a signal in the CHOP mode. This mode performs the same operation as that of DUAL in the STORAGE mode.

NOTE:

To prevent triggering from chopping transients, apply a triggering signal of a large level synchronized to the measuring signal to the EXT INPUT connector and set the TRIGGER SOURCE to EXT, or set the internal trigger level very appropriately.

ADD: The algebraic sum of CH1 and CH2 is displayed when both CH1 and CH2 switches are pressed. This is the same in the STORAGE mode.

CH2 INVERT:

The polarity of the CH2 signal is inverted. It is recommended to use this function when comparing the waveforms with different polarities or when measuring the difference signal between CH1 and CH2.

BW LIMIT (only valid for a trigger signal in the STORAGE mode):

When this switch is pressed, the bandwidth is reduced to approximately 20 MHz (10 MHz for the VC-6025) and the measurement is made by eliminating undesired high frequency signals from the waveform. The high frequency component over 20 MHz (10 MHz for the VC-6025) is also eliminated from the trigger signal.

(3) Horizontal deflection system

⑭ HORIZONTAL MODE switch

Selects the operation mode of the horizontal deflection.

A: Main sweep (A) appears on the CRT.

This setting is used in normal cases.

ALT: Both the main sweep (A) and the delayed sweep (B) are displayed.

In the STORAGE mode, the operation is the same as that in the A mode, and the sampling is performed at the speed corresponding to the A sweep time range.

B: The delayed sweep (B) appears on the CRT. The sweep time is controlled by the B time base.

In all the STORAGE modes other than the ROLL mode, the B sweep sampled at the speed corresponding to the B sweep time range is displayed when the A sweep time is from 2.5 μ s/DIV to 0.1 s/DIV (5 μ s/DIV - 0.1 s/DIV for the VC-6025).

X-Y: When the ALT and B switches are pressed simultaneously, an X-Y operation is available.

①5 SELECTOR switch

This switch selects a parameter switch function related to the horizontal axis or a cursor measurement function. Move the SELECTOR switch lever upward (Δ) or downward (∇) until the desired function lamp lights. Then adjust the VARIABLES control ①6 appropriately.

NOTE:

The following functions can be selected either in the REAL TIME mode or the STORAGE mode. Moreover, in the STORAGE mode, the storage functions can be selected by the SELECTOR switch on the STORAGE MODE section (Front panel B section). When the MENU function is selected, all the lamps of the following functions go off. Use this switch to return to the following functions again.

- SINGLE: Displays the main sweep (A) once.
- SEP: Adjusts the vertical position of the delayed sweep (B) in the ALT sweep mode.
- DELAY: Used to set the delay time of the delayed sweep (B) starting point with respect to the main sweep (A) starting point. The delay time is displayed on the upper left side of the CRT and the B sweep window is indicated by the cursors.
- HOLDOFF: Rotate the HOLDOFF control to obtain stable triggering for a complex signal, a high-frequency signal, an irregular signal, etc. The holdoff value is set to the minimum when the power is turned on or when the A TIME/DIV switch ①8 is operated.
- TIME (Variable):
Adjusts the sweep speed of the main sweep (variable) (A) continuously. When the control is turned fully clockwise, the sweep speed is calibrated to the specified value (CAL state). Normally, set to the fully clockwise position (A = on the CRT).

The variable time is set to the CAL state when the power is turned on or when the A TIME/DIV switch is operated. (Only in the REAL TIME mode)

H POS: This switch moves a trace to the horizontal direction. Clockwise rotation moves a trace to the right side. Counterclockwise rotation moves a trace to the left side. In the STORAGE mode, the trigger point is moved at the normal storage operation (2.5 μ s/DIV to 0.1 s/DIV for the VC-6045, and 5 μ s/DIV to 0.1 s/DIV for the VC-6025).

MEASURE: In this mode, ΔV , ΔT and $1/\Delta T$ can be selected and displayed in turn on the CRT by pressing the SELECTOR switch, and measurements by cursors are available.

ΔV : Two horizontal cursors appear. The voltage between the two cursors is calculated according to the setting of VOLTS/DIV, and displayed with ΔV on the upper side of the CRT.

ΔT : Two vertical cursors appear. The time between the two cursors is calculated according to the setting of TIME/DIV, and displayed with ΔT on the upper side of the CRT.

$1/\Delta T$: Two vertical cursors appear. The reciprocal of the time (frequency) between the two cursors is calculated according to the setting of TIME/DIV, and displayed with $1/\Delta T$ on the upper side of the CRT.

①⑥ VARIABLES control

This control sets the function selected by the SELECTOR ①⑤. Clockwise rotation moves the trace upward (\uparrow) or rightward (\rightarrow). Counterclockwise rotation moves the trace downward (\downarrow) or leftward (\leftarrow).

A combination use with the SELECTOR can blank the readout on the CRT and calculate values of the 1X and 10X modes of a probe. When the MENU is selected in the STORAGE mode, the interpolation method, the number of average, and ON/OFF of the smoothing can be set.

①7 CURSORS REF·Δ·TRACKING control

REF: Moves the reference cursor on the CRT. (▽ or ▷ is displayed on the reference cursor.)

Δ: Moves the measuring cursor on the CRT. (▽ or ▷ is displayed on the measuring cursor.)

TRACKING: Simultaneously moves the reference cursor and the measuring cursor with the interval between the two cursors unchanged. (▽ or ▷ is displayed at the two cursors.)

①8 A AND B TIME/DIV switch

This switch sets the sweep time of the main sweep (A) and the delayed sweep (B). The sweep is set by the HORIZONTAL MODE switch ①4 and the TIME/DIV setting data is displayed on the CRT.

In each operation mode, the following sweep time is selectable.

* REAL TIME mode:

A sweep time: 50 ns/DIV to 0.5 s/DIV (22 steps)

B sweep time: 50 ns/DIV to 50 ms/DIV (19 steps)

A TIME/DIV \geq B TIME/DIV

* STORAGE mode:

A sweep time: 50 ns/DIV to 50 s/DIV (28 steps)

B sweep time: 2.5 μ s/DIV to 50 ms/DIV

(5 μ s/DIV to 50 ms/DIV for the VC-6025)

(14 or 13 steps)

A TIME/DIV \geq B TIME/DIV

NOTES:

(a) In the STORAGE mode, the sampling method is changed automatically by the TIME/DIV.

50 ns/DIV to 2 μ s/DIV Equivalent sample

(Only a repetitive signal
can be stored.)

2.5 μ s/DIV to 0.1 s/DIV ... Normal sample

(5 μ s/DIV to 0.1 s/DIV for the VC-6025)

0.2 s/DIV to 50 s/DIV ROLL mode

(b) Only a completely repetitive signal can be stored in each range from 50 ns/DIV to 2 μ s/DIV of the A sweep time (equivalent sampling mode range).

When a signal containing a non-repetitive component is stored in these ranges, the waveform different from the input signal may be displayed or the waveform on the CRT may not be updated with the STORAGE lamp (green LED) lit.

In case of measuring a non-repetitive signal, set the range to 2.5 μ s/DIV (5 μ s/DIV for the VC-6025) or slower.

AUTO

When the center of the TIME/DIV switch is pressed, the AUTO lamp lights, and the input signal is detected. Then the time range is changed automatically, and the waveform of approximately 1.6 to 4 cycles is displayed on the CRT. (But when the input signal is lower than 100 Hz or not triggered properly, the time range is set to 5 ms/DIV. When the signal is higher than approximately 8 MHz, the time range is set to 50 ns/DIV, the highest speed range.) Moreover, the time range automatically follows the change of the input signal.

①9 X10 MAG switch

This switch is used to magnify A and B sweeps by 10 times. In the REAL TIME mode, bring the portion of the waveform to be magnified to the center of the CRT by the H POS control. Then press the X10 MAG switch to magnify the waveform in the horizontal direction. In the STORAGE mode, the storage waveform at 1 division from the MAG point marker is magnified by 10 times in the horizontal direction.

(4) Trigger system

⚠ (20) EXT INPUT connector

This is a BNC connector for an external trigger signal, an external sweep signal, or an external X input.

(21) TRIGGER SOURCE OR X switch

In the REAL TIME mode, this switch selects the trigger signal source or the X signal for an XY operation.

In the STORAGE mode, this switch selects only the trigger signal source. (The CH1 signal becomes the X signal for an XY operation in the STORAGE mode.)

CH1: The signal fed to CH1 is used as a signal source.

CH2: The signal fed to CH2 is used as a signal source.

EXT AC: The signal fed to EXT INPUT is used as a signal source after the DC component and the very low frequency component are removed.

EXT DC: The signal fed to EXT INPUT is used as a signal source as is. This signal is used when affecting synchronization to a very low frequency.

EXT DC:10:

The signal fed to EXT INPUT is attenuated to 10:1 and used as a signal source. This signal is used when affecting synchronization to a very low frequency.

LINE: Used to measure the signal synchronized to a line frequency.

(22) TRIGGER MODE switch

AUTO: A sweep is performed automatically. When a trigger signal is applied, the normal sweep operation is performed and the waveform is stationary.

The instrument will automatically display a trace without an input signal being applied or out of trigger. This setting is convenient in most cases.

Normal trigger will be established by setting trigger level when a signal is applied to the input.

In the STORAGE mode, a waveform displayed on the CRT continues to be updated regardless of the presence of a trigger signal.

The trigger level automatically corresponds to the amplitude of the incoming signal and the signal is easily triggered.

NORM: Trace will appear when a sweep is triggered. Trace will not appear when a signal is not applied or when a signal is triggered properly. Use this MODE when effecting synchronization to a very low frequency signal (30 Hz or less) or for arming a single sweep. When the signal is not triggered properly in the STORAGE operation, a waveform is not updated and the traces are held.

TV-V: Used when measuring the vertical TV signal.

TV-H: Used when measuring the horizontal TV signal.

②③ TRIGGER LEVEL control

By controlling the trigger level, the sweep start point of the waveform is set.

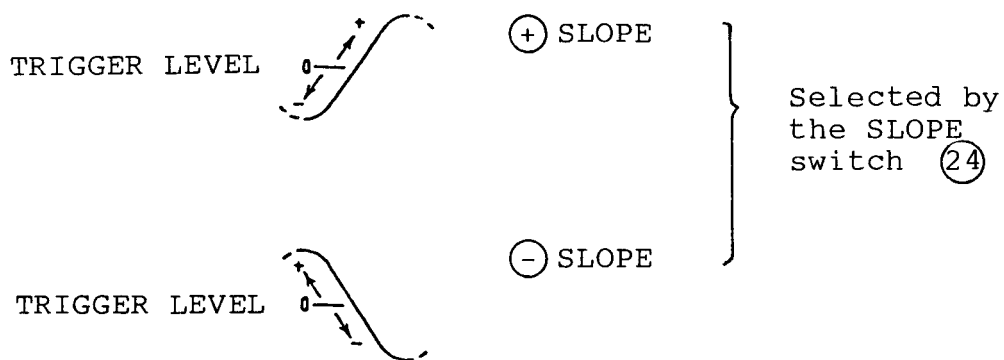

24 SLOPE switch

This switch selects the slope of the signal that triggers the sweep.

When the switch is pressed in () , sweep is triggered from the negative-going slope of the trigger signal.

When the switch is pulled out () , sweep is triggered from the positive-going slope of the trigger signal,

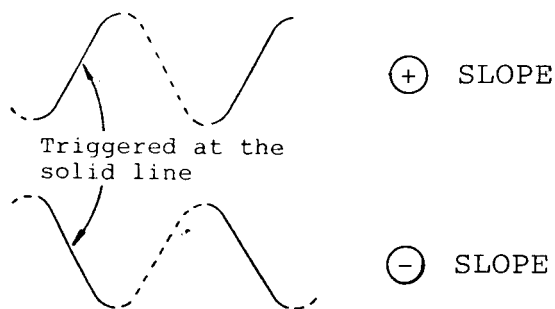

25 TRIGGER LOCK/SINGLE RESET

When **SINGLE** is not selected by the SELECTOR switch (15) :

When the TRIGGER LOCK switch is pressed and the lamp is lit, the triggering state before the lamp is lit is held. If the TRIGGER LOCK switch is pressed with the triggering executed before the lamp is lit, and the stable triggering is ensured when the sweep time and the variable time are changed.

When **SINGLE** is selected by the SELECTOR switch (15) :

When the SINGLE RESET switch is pressed and the lamp is lit, the single sweep is armed.

NOTE:

When the TRIGGER MODE switch is set to AUTO, the sweep is performed once by pressing this switch, asynchronously with the incoming signal. Usually the single sweep function is used in conjunction with NORM triggering to detect and trigger on abnormalities, aberrations, or one time events.

(5) Miscellaneous

(26) PROBE ADJUST terminal

A 0.5V, 1 kHz square wave signal is available. This terminal is used for probe calibration.

(27) GND terminal (\perp)

Grounding terminal

5.2 Front Panel Section B

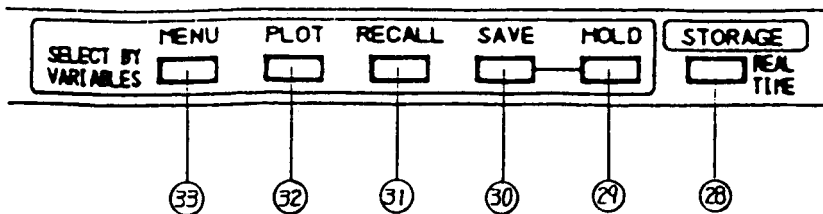

Fig. 5-2 Front Panel B section

(28) STORAGE switch

When this LED goes off, the instrument functions as the normal real-time oscilloscope, the switches (29) thru (33) are all invalid, and all the LED's go off.

When this switch is pressed once, the LED lights, resulting in the STORAGE mode. In this case the switches (29) thru (33) are all valid.

When this switch is pressed again in the STORAGE mode, the REAL TIME mode is established again. In the STORAGE mode, the LED blinks in synchronism with sampling.

(29) HOLD switch

Pressing this switch stops sampling, resulting in the hold state, and the LED lights.

Further pressing this switch releases the hold state and sampling starts.

30 SAVE switch

This is the switch to store the display waveform in the save memory. This switch is valid only in the hold state (HOLD LED lights).

When this switch is pressed, the LED lights to indicate that the waveform is stored in the save memory.

31 RECALL switch

This is the switch to display the saved waveform on the CRT again. When this switch is pressed, the LED lights.

The RECALL state is released by pressing this switch.

32 PLOT

Press this switch to output the display waveform to the X-Y plotter connected externally. Then data starts to be transmitted and the LED lights. This switch is valid only in the hold state (HOLD LED lights).

33 MENU

Press this switch to change the number of average, the interpolation method and the on-off of smoothing. Each pressing changes the setting mode and the present setting mode is displayed at the top right on the CRT. The settings in each mode are changed by the VARIABLES control 16.

5.3 Rear Panel

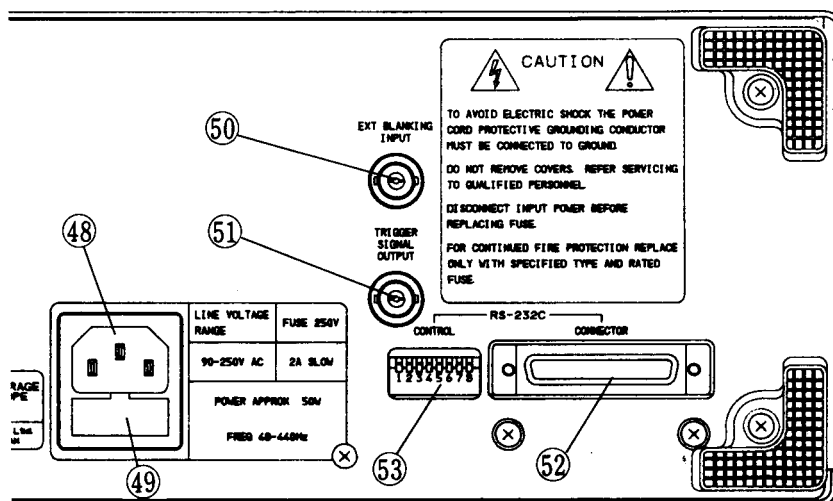

Fig. 5-3 Rear panel

④8 AC input connector

Connect the AC power source.

④9 FUSE

The fuse is inside the fuse holder.

CAUTION:

When the fuse is blown out, contact your nearest Hitachi Denshi representative.

④0 EXT BLANKING INPUT terminal

This is a terminal for applying a blanking signal from an external source. This terminal is DC-coupled.

The intensity is lowered by a positive signal, while it is increased by a negative signal.

④1 TRIGGER SIGNAL OUTPUT connector

The signal selected by the TRIGGER SOURCE or X control ④1 is available.

④2 RS-232C connector

Connect to the plotter or other equipment with the RS-232C interface.

④3 RS-232C switches

The eight switches set the address of the instrument with the binary data. (Refer to item 9.2 Specifications of Plot.)

6. HOW TO PRODUCE THE TRACE

At first, verify that the AC supply voltage is within the specified range.

Then connect the power cord on the rear panel to an AC outlet and set the controls as follows.

GND	:	<u> </u>	(Pressed mode)
POSITION	:	Midrange	
HORIZONTAL MODE	:	A	
TRIGGER MODE	:	AUTO	
VERTICAL MODE	:	CH1	

After completion of the above settings, turn on the POWER switch. The LED's on the front panel light for a while, and soon unnecessary LED's go off.

Press this switch to establish the REAL TIME mode while the green STORAGE LED lights.

When the INTEN control is turned clockwise, the trace appears. For immediate measurement, adjust the FOCUS control to obtain the sharpest possible trace.

Align the GND trace with the horizontal graticule line at the center of the screen by operating CH1 POSITION control. In some cases, the trace may be slightly oblique to the scale by the effect of earth magnetism.

In this case, align the trace with the horizontal graticule line at the center of the screen by properly adjusting the TRACE ROTATION control (screwdriver adjustment) on the front panel.

When this instrument is not in use, with power supplied, rotate the INTEN control counterclockwise to decrease the intensity. This protects the CRT from burning and prolongs its life.

NOTES:

For normal operation, the following function must be set to the 'CAL' position.

VOLTS/DIV VAR: Rotate fully clockwise. In this case, the VOLTS/DIV is calibrated to the indicated value and is changed from the UNCAL display " > " to the calibration display "Blank".

TIME/DIV VAR: Set the TIME by the SELECTOR 15 , and turn the VARIABLES control clockwise until A = is displayed on the CRT.

The variable time is initialized when the power is turned on or when the time range of the A sweep is changed. At this time, the A TIME/DIV is calibrated to the indicated value.

7. METHOD FOR CONNECTING SIGNALS

The first step of measurement is to connect the signal to the instrument properly. Do it with utmost care.

WARNING:

When connecting the probe or the signal input cable to the circuit to be measured, be sure to connect the ground side of the probe or the signal input connector to the ground side of the signal source.

If not, potential difference between the instrument and other equipment or earth ground may result in shock hazard and damage the instrument, the probe, and other equipment.

(1) Using probes

Use the supplied probe when measuring a high frequency signal.

Supplied probe: AT-10AP1.5

When the X10/X1 switch on the probe is set to X10, the input signal is attenuated by this probe to 1/10.

This position is convenient to measure a large signal because a measuring range is expanded, though the position is inconvenient for a small signal.

When the input signal level is so low as not to be measured at the X10 position setting, the switch must be set to X1.

In this case, the input impedance is different and the measureable frequency bandwidth becomes extremely low. (For further details, refer to the operation manual of the supplied probe.)

NOTES:

- a) Do not apply a signal in excess of 500 V (DC + peak AC at 1 kHz or less) to the input.
- b) Connect the probe ground lead as close as possible to the point being measured especially when measuring a signal with a fast rise time or a high frequency signal. Long probe ground leads may cause waveform distortions, such as ringing and overshoot.

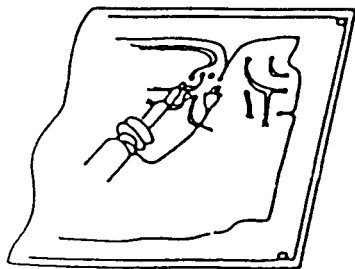

(a) Proper

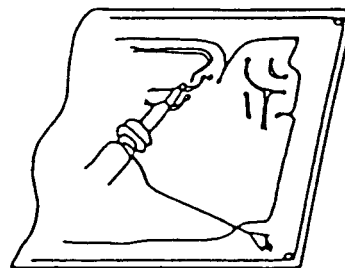

(b) Improper

Connection of ground lead

- c) To avoid effect of the ground lead in high frequency measurement, it is recommended to use the standard ground lead attachment with the AT-10AP1.5 probe.
- d) To avoid a measurement error, probe compensation must be done especially when probes are changed. Connect the probe tip to the PROBE ADJUST 0.5 V output terminal and the probe ground lead to the GND terminal. A 1 kHz square wave should be displayed with flat tops. Any distortion in the presentation is caused by incorrect probe compensation. If overshoot or undershoot is present, turn the screwdriver adjustment in the probe for a flat-top presentation.

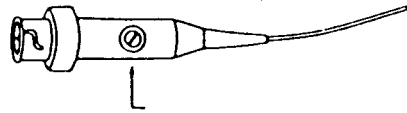

Screwdriver adjustment



(a) Optimum



(b) Capacity too small



(c) Capacity too large

(2) Direct connections

When connecting signals without using the supplied probe, pay attention to the following points in order to minimize a measurement error.

- o When using an unshielded lead, there should be no trouble, provided the circuit under measurement is of low impedance source and high level. However, in most cases, measurement errors may be caused by stray coupling with other circuits or power line interference. This can cause errors even at low frequencies. In general, avoid measuring with an unshielded lead.
- o When using a shielded wire, it is desirable to use a coaxial cable with a BNC type connector. If a BNC type connector is not available, connect one end of the shield to the ground terminal of the instrument and the other end to the ground of the circuit to be measured.

- o The following precautions must be observed when performing a wide bandwidth measurement. It is necessary to terminate the cable with a characteristic impedance, when measuring a fast rise waveform or a high frequency wave. The absence of a termination resistor will result in a measurement error due to a ringing phenomenon when a long cable is used. Some measuring circuits require a termination resistor equal to the characteristic impedance of the cable. (A BNC type termination resistor is recommended for this purpose).
- o In order to perform measurements with the circuit in a proper operating state, it is sometimes necessary to terminate the cable with an impedance which corresponds to the circuit being measured.
- o The stray capacity of the shield wire must be taken into account when performing measurements with a long shield wire. Since a shield wire has a capacity of about 100 pF per meter, its effect on the test circuit cannot be ignored.

Use a X10 probe to minimize the effect on the circuit.

- o When a shield wire or a non-terminated cable is used, and the cable length reaches $1/4$ the wave length or its multiples ($1/4$ the wave length is about 0.5 meter when using a coaxial cable at 100 MHz), oscillation may be caused in the 2 to 5 mV/DIV ranges.

This is caused by the resonance between the externally connected high-Q inductance and the input capacity. Reduce the Q by connecting the cable or shield wire to the input connector by the resistors from 100 Ω to 1 k Ω connected in series, or by performing measurements at another VOLTS/DIV range.

8. BASIC OPERATIONS AND MEASUREMENT PROCEDURES

The measurement is provided with the REAL TIME mode function and the STORAGE mode function, and the selection of the modes can be made by the switches of the STORAGE MODE section. The basic operations are described below.

NOTE:

Prior to measurements, allow 20 minutes of warmup time.

8.1 Data Display

(1) REAL TIME mode display

Data display positions on the CRT

Delay time, holdoff, cursor measurement value

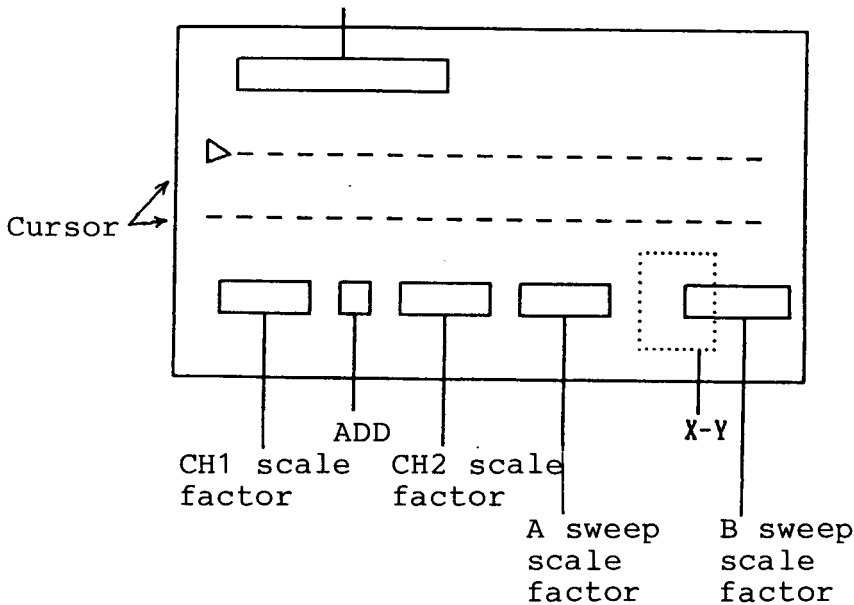

① CH1 and CH2 scale factor displays

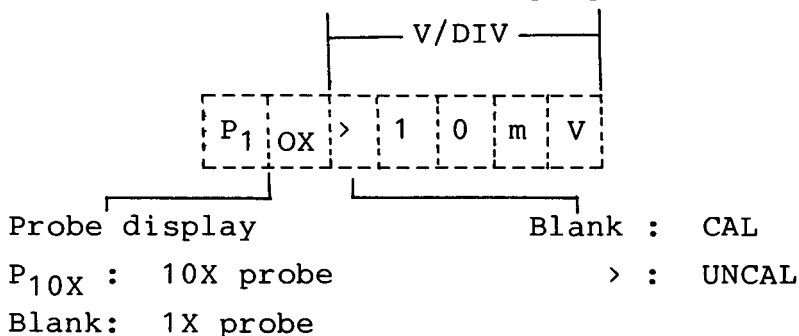

In the ADD mode, "+" is displayed between scale factors of CH1 and CH2.

② A and B sweep scale factor displays and X-Y display

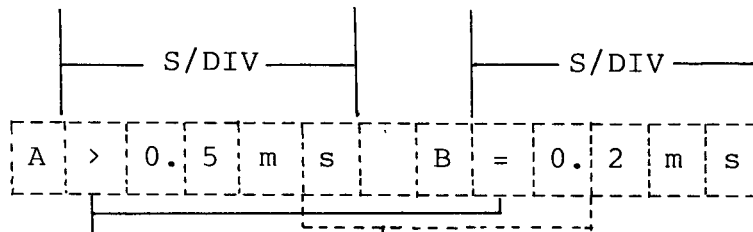

=: X1 CAL
 *: X10 MAG
 >: UNCAL

In the X-Y operation mode, X-Y is displayed and the TIME/DIV setting data disappears.

③ Delay time display

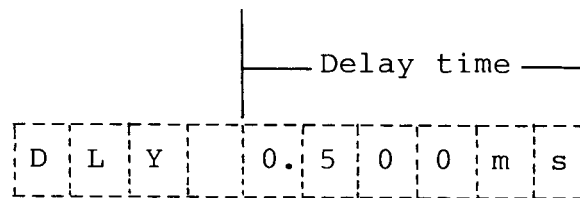

ms : A TIME/DIV (CAL)
 div: A TIME/DIV (UNCAL)

Shows that the HORIZONTAL MODE switch is set to ALT or B.

④ HOLDOFF and TRIGGER LOCK displays

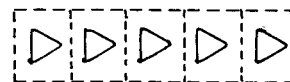

MIN: Minimum
 ▷▷▷: Holdoff time is graphed.
 MAX: Maximum

T	R	I	G	G	E	R	L	O	C	K
---	---	---	---	---	---	---	---	---	---	---

Displayed in the TRIGGER LOCK mode.

5) Cursor measurement value display

A measurement value between cursors is displayed.

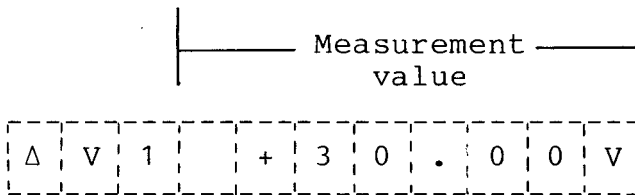

$\Delta V1$: CH1

$\Delta V2$: CH2

ΔV^1_2 : ADD

ΔTA : Time difference between two cursors for A TIME/DIV

$1/\Delta TA$: Reciprocal number of ΔTA

ΔTB : Time difference between two cursors for B TIME/DIV

$1/\Delta TB$: Reciprocal number of ΔTB

ΔV : +, -, mV, V, div

ΔT : +, -, ns, μ s, ms, s, div

$1/\Delta T$: mHz, Hz, kHz, MHz, ?

"div" is displayed in the following cases:

- o The measurement value in the channel selected by the VERTICAL MODE switch is not in the CAL state.

- o The VERTICAL MODE is set to ADD, and the VOLTS/DIV settings of CH1 and CH2 are not equal.

- o The HORIZONTAL MODE switch is A, and the TIME switch and the VARIABLES control function.

(UNCAL state, CRT display:>)

(2) STORAGE mode display

Data display positions on the CRT

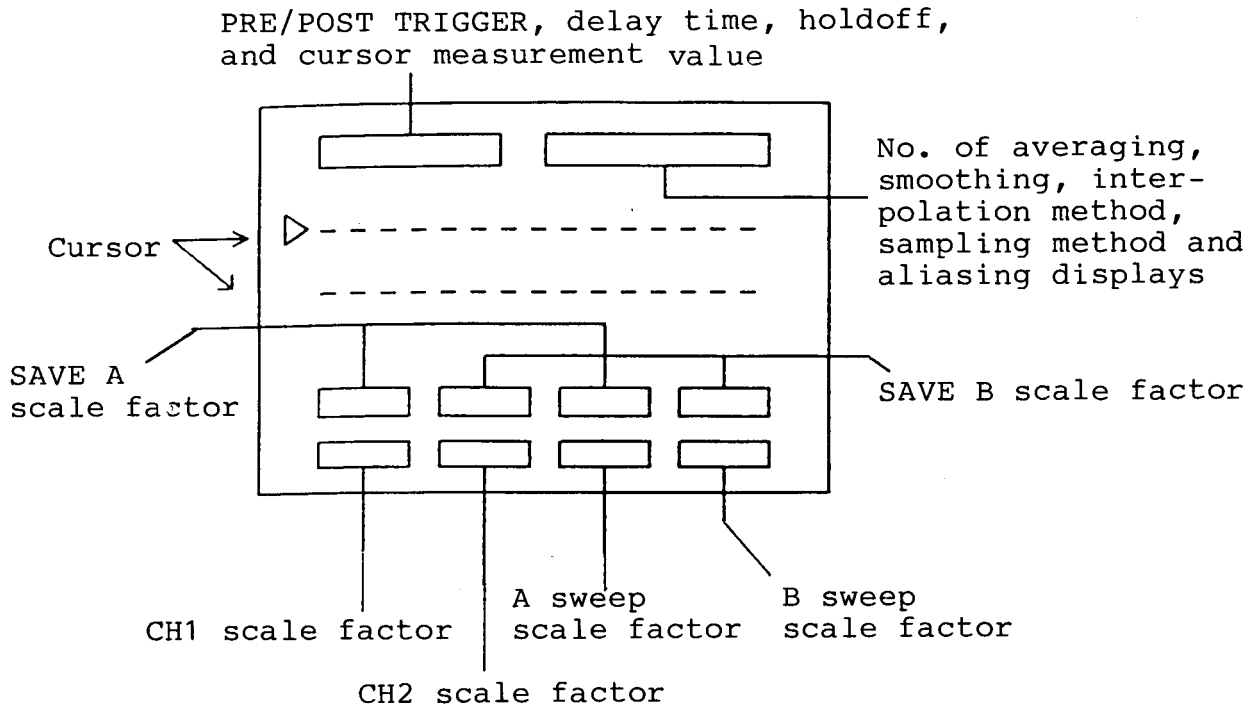

NOTE:

In the STORAGE MODE, the waveform can be displayed while the input signal is stored. Moreover, the waveform previously stored can be displayed.

The instrument stores the scale factor and the setting conditions related to the waveforms as far as the waveform is stored. When the waveform is displayed, these values can be displayed at any time.

o CH1, CH2, A sweep and B sweep scale factors

When the waveform of CH1 or CH2 is displayed, the scale factors corresponding to the waveform are displayed as shown in page 46.

o PRE/POST TRIGGER, hold-off, delay time, and cursor measurement

The cursor measurement value of the sweep waveform corresponding to the function selected by the SELECTOR switch and the VERTICAL MODE switch is displayed.

o SAVE A and SAVE B scale factors

The V/DIV and TIME/DIV are displayed when the waveform is saved in the save memory.

This scale factor is displayed only when the save waveform is displayed on the CRT by pressing the RECALL switch.

① CH1 and CH2 scale factor displays

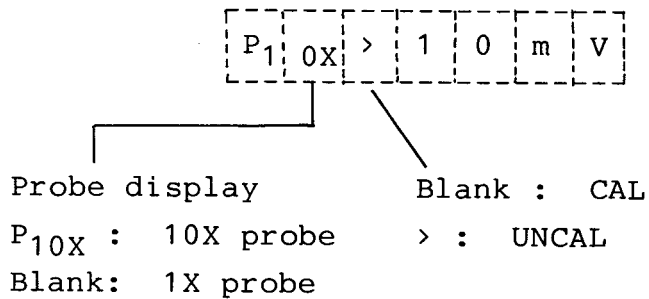

② A and B sweep scale factor displays and X-Y display

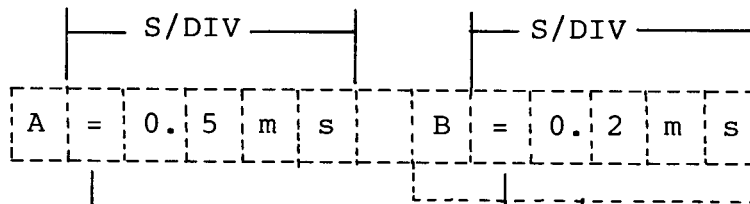

- = : X1 CAL(No horizontal magnification)
 - * : No interpolation
 - ∩ : Sine interpolation
 - ┌ : Linear interpolation
- } X10 MAG
(Horizontal magnification)

In the X-Y operation, the scale factor of the B sweep disappears, and the X-Y is displayed. This means that the waveform stored with the scale factor of A sweep is displayed in the X-Y mode.

③ **PRE/POST TRIGGER setting display**

Display of the trigger point of the display waveform
Triggering point of the waveform

(Example:

T	R	I	G	+	9	.	9	d	i	v
---	---	---	---	---	---	---	---	---	---	---

)

④ **Delay time display**

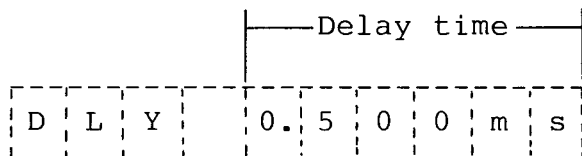

Shows that the HORIZONTAL MODE switch is set to ALT or B.

⑤ **HOLDOFF and TRIGGER LOCK displays**

H	O	L	D	O	F	F
---	---	---	---	---	---	---



MIN: Minimum

▷▷▷: Holdoff time is graphed.

MAX: Maximum

T	R	I	G	G	E	R	L	O	C	K
---	---	---	---	---	---	---	---	---	---	---

Displayed in the TRIGGER LOCK mode.

⑥ **Displays of No. of averaging, smoothing, interpolation method and sampling method**

For these displays, refer to items 8.3 (11) and (12).

⑦ Cursor measurement value display

A measurement value between cursors is displayed.

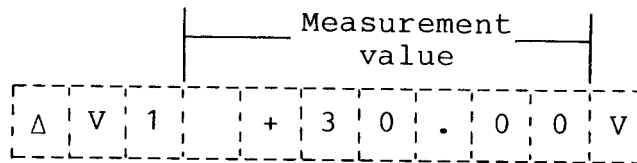

- | | |
|-----------------------------------------------------------------------------------------------------------------------------------------------------------------------------------------------------------------------------------------------------------------------------------------------------------------------------------------------------------------------------------------------------------------------------------------------------------------------------------------------------------------------------------------------------|-----------------------------------------------------------------------------------------------------------------------------------------------------------------------------------------------------------------------------------------------------------------------------------------------------------------------------------------------------------------------------------------------------------------------------------------------------------------------------------|
| <p>$\Delta V1$: Voltage difference between two cursors for the CH1 sweep waveform</p> <p>$\Delta V2$: Voltage difference between two cursors for the CH2 sweep waveform</p> <p>ΔTA: Time difference between two cursors for the A sweep waveform</p> <p>$1/\Delta TA$: Reciprocal number of ΔTA</p> <p>ΔTB: Time difference between two cursors for the B sweep waveform</p> <p>$1/\Delta TB$: Reciprocal number of ΔTB</p> | <p>ΔV: +, -, mV, V, div</p> <p>ΔT: +, -, ns, μs, ms, s</p> <p>$1/\Delta T$: mHz, Hz, kHz, MHz, ?</p> <p>"div" is displayed in the following cases:</p> <ul style="list-style-type: none"> o The measurement value in the channel selected by the VERTICAL MODE switch is not in the CAL state. o The VERTICAL MODE is set to ADD, and the VOLTS/DIV setting of CH1 and CH2 are not equal. |
|-----------------------------------------------------------------------------------------------------------------------------------------------------------------------------------------------------------------------------------------------------------------------------------------------------------------------------------------------------------------------------------------------------------------------------------------------------------------------------------------------------------------------------------------------------|-----------------------------------------------------------------------------------------------------------------------------------------------------------------------------------------------------------------------------------------------------------------------------------------------------------------------------------------------------------------------------------------------------------------------------------------------------------------------------------|

NOTES:

- a) Readout display appears when the power is turned on. If this display is not needed, select H POS by the SELECTOR switch, and rotate the VARIABLES control counterclockwise while holding the SELECTOR switch upward. The readout display then disappears. To obtain the readout display again, select H POS, and rotate the VARIABLES control clockwise, while holding the SELECTOR switch upward.
- b) The P_{10X} display is initialized when the power is turned on. To blank the display, select H POS by the SELECTOR switch, and rotate the VARIABLES control counterclockwise while holding the SELECTOR switch downward.

To obtain the display again, select **H POS**, and rotate the VARIABLES control clockwise, while holding the SELECTOR switch downward.

The probe display can be switched to 1X or 10X only for the channel selected by the VERTICAL MODE switch.

8.2 REAL TIME Mode

The instrument works as a conventional oscilloscope.

(1) Normal sweep display

- ① Set the switches, and controls as shown in Table 8-1. Check that the green LED of the STORAGE switch goes off. If not, press this switch to establish the REAL TIME mode.

Table 8-1 Initial setting of basic display

Vertical axis	VOLTS/DIV VAR AC-DC GND POSITION VERTICAL MODE	Set according to the amplitude of the applied signal. CAL (Fully clockwise) AC Off (Pulled out) Mid-position CH1
CRT	INTEN FOCUS	Proper position Mid-position
Horizontal axis	HORIZONTAL MODE X10 MAG	A Off (Pulled out)
Trigger	TRIGGER LEVEL TRIGGER MODE SOURCE OR X	Mid-position AUTO CH1

- ② Connect the signal to CH1 INPUT connector using a probe or a coaxial cable which meets the input impedance. Refer to Section 7 for connection.
- ③ Adjust the INTEN control for proper illumination.
- ④ Adjust the VOLTS/DIV of CH1 and the vertical POSITION control so that the trace is displayed within the screen.
- ⑤ Adjust the TRIGGER LEVEL control for stable display.
- ⑥ Adjust the TIME/DIV switch so that the trace is displayed at a proper cycle. Use the FOCUS control, if necessary.

(2) In the case of measuring a single waveform

Use CH1 or CH2 when measuring a single waveform. Make the following settings when using CH1:

VERTICAL MODE switch:	CH1
TRIGGER SOURCE OR X switch:	CH1
TRIGGER MODE switch:	AUTO
AC-DC switch:	AC or DC

Under these settings, almost all the repetitive signals of approximately 30 Hz or more supplied to CH1 can be triggered and measured by adjusting the TRIG LEVEL control (within high sweep range from 2 ms/DIV of the TIME/DIV switch.)

Since the TRIGGER MODE of the horizontal axis is at AUTO, the trace appears even when no signal is present or when the GND switch is at GND. This means that the DC voltage can be measured. The following switching is needed when measuring low frequency signals of approximately 30 Hz or less.

TRIGGER MODE switch:	NORM
----------------------	------

Triggering can be effected by operating the TRIG LEVEL control under this setting.

When using CH2 only, use the instrument after making the following settings.

VERTICAL MODE switch:	CH2
TRIGGER SOURCE OR X switch:	CH2

(3) In the case of measuring two waveforms

Measurement of two waveforms can be made easily by setting the VERTICAL MODE select switch to DUAL.

NOTES:

- a) When the A TIME/DIV setting is at 5 ms/DIV or slower in the DUAL mode, the mode is automatically set to the CHOP mode.
When the TIME/DIV setting is at 2 ms/DIV or higher, the mode is automatically set to the ALTERNATE mode.
If the CHOP mode is required when the TIME/DIV setting is at 2 ms/DIV or higher, press both the CH1 and DUAL switches.
- b) To measure the phase difference, trigger on the leading signal.

(4) In the case of measuring a waveform in the X-Y mode

When the HORIZONTAL MODE is set to X-Y, this instrument operates as an X-Y oscilloscope.

The X (horizontal) axis input is selected by the TRIGGER SOURCE OR X. The Y (vertical) axis input can be used in CH1, CH2, and the dual trace.

NOTES:

- a) Set the horizontal magnifying switch (X10 MAG) to off.
- b) Set the BW LIMIT 20 MHz (10 MHz for the VC-6025) switch to off.

8.3 Digital Storage Functions

The operating procedures of the digital storage functions are described below.

(1) Normal storage mode (NORM)

- ① Display the waveform to be stored in the REAL TIME mode.
- ② Press the NORM switch.
- ③ In this mode, a waveform is swept every trigger according to the setting state of controls on the front panel, the waveform to be stored is displayed on the CRT as it is. The slower the sweep rate, the longer the time is required for the acquisition and display of the waveform. It takes approximately 12 seconds until a waveform is acquired at the sweep range of 0.5 s/div. The trigger signal is generated thereafter. Therefore, when the sweep rate is slow, the waveform is not displayed on the CRT immediately after the controls on the front panel have been adjusted.
- ④ When the TIME/DIV control is from 2.5 μ s/div (5 μ s/div for the VC-6025) to 0.5 s/div (17 steps), both the single and the repetitive waveforms can be stored.
- ⑤ When the HOLD switch is pressed in the normal storage mode, the updating operation of the CRT display stops, and the CRT display at that time can be held. Precautions for the repeat mode range are shown below.

(2) Equivalent sampling mode (EQUIV)

When the TIME/DIV switch is set to 50 ns/div to 2 μ s/div (6 steps), only the repetitive waveform can be stored in the equivalent sampling mode. Note the following items in this mode.

- a) The first (left end) rising and falling edges of the trace may not be displayed in the repeat mode range. In this case, measure the rising or falling edge on the second or later cycles of the waveform.

First (left end) rising and falling edge of the trace can not be measured.

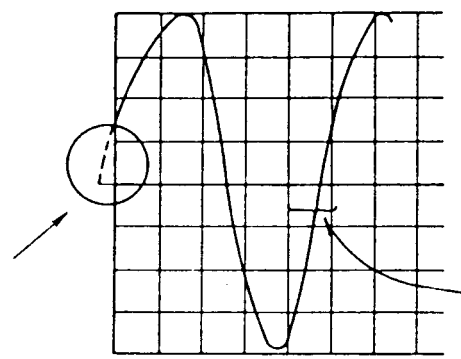

Measure the rising and falling edges of the trace on and after the second cycle of the waveform.

Display in the equivalent sampling mode

- b) It takes 5 seconds or more to store the input signal of 1 kHz or lower (for the 200 Hz input).
- c) When the low frequency signal is stored, noise can be mixed. It is recommended to use a sine wave of 1 MHz or higher or a square wave with the rise time which is faster than 0.3 μ s.

NOTE:

The sampling rate in the STORAGE mode
 In the normal display without horizontal magnification in the STORAGE mode, the horizontal full scale of 10 div on CRT consists of 1000 sampling data.

(3) ROLL mode

The displayed waveform is rolled from right to left (0.2 s/div to 50 s/div). The right end of each trace is the updating point of a new data.
 The ROLL mode facilitates measurement of a signal of approximately 100 Hz or lower.
 Press the HOLD switch to stop the ROLL mode and hold the final waveform on the CRT.

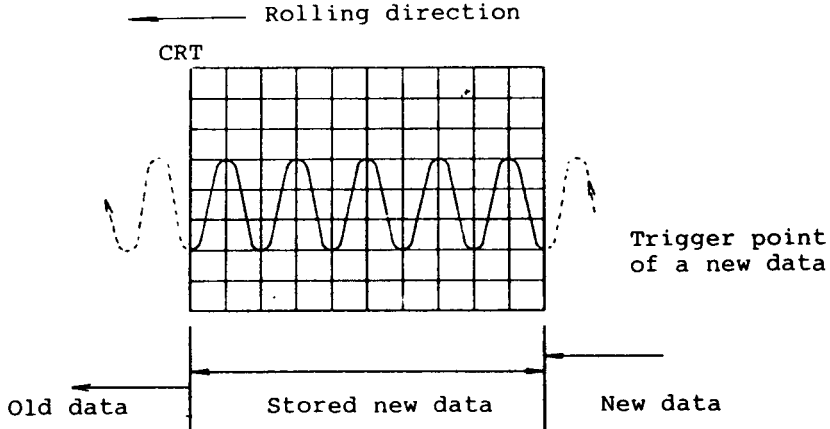

NOTES:

a) Discrimination of aliasing

When measuring the signal in such STORAGE mode as NORM, AVG, etc., aliasing can occur when an input signal which has more than half of the frequency with respect to the sample clock frequency at the sweeping range is added.

When aliasing occurs, the waveform of the input signal frequency minus the sample clock frequency will be displayed. It is possible that this display is judged a correct waveform. Consequently, the warning message ALIAS 2 is displayed for less than 2 samples per input signal cycle, and ALIAS 10 is displayed for less than 10 samples per input signal cycle.

b) Updating of the roll waveform

The roll mode at the high speed ranges (up to 0.2 s/div) is available. For some input signal, the movement of its waveform may not be seen smoothly at the range from 0.2 to 0.5 s/div. This phenomena is caused by the relationship between the updating of the waveform data and the display speed. Actually the waveform data itself is correct.

c) Note on the ROLL mode operation

Set the HORIZONTAL MODE switch to A (or X-Y) to measure a waveform in the ROLL mode. When the switch is set to ALT or B, it is impossible to change of time range and to perform the cursor measurement. (The delay sweep can not be performed.)

(4) SINGLE mode

When the SINGLE switch mode is selected by the SELECTOR switch in the STORAGE mode, the sampling of each operation mode is processed for one screen data.

① Single operation procedure

a) Establish the STORAGE mode (50 ns/div to 0.1 s/div, invalid in the ROLL mode) and adjust the controls so that the input signal is stored and displayed in the operation mode.

- b) Set the TRIGGER MODE switch to NORM, and set the TRIGGER LEVEL at the proper position to measure the input signal.
- c) Establish the SINGLE mode by the SELECTOR switch.
- d) Press the SINGLE RESET switch to establish the trigger wait mode (LED lights).
- e) When the trigger signal is supplied, the waveform data corresponding to one screen is sampled. When all the data are prepared, the screen display is updated. This is effective for the storage of a transient waveform.

NOTE: AVG mode

A trigger signal in excess of the number of the designated sweep must be fed.

A sampling of 1000 data (corresponding to one sweep) is performed whenever a trigger signal is fed, and the data is accumulated. When the number of the designated sweep finishes, the accumulated waveform data is averaged, and the result is displayed on the CRT.

- o When the above operation mode is processed once, the SINGLE operation finishes, and the LED above the PLOT switch goes off. The waveform on the CRT is held.
- ② When the SINGLE switch is pressed in the above operation, the instrument is placed in the wait state of a trigger signal. The SINGLE sampling processing is not performed until the trigger signal is applied.
While the trigger of the input signal is not detected, the SINGLE RESET LED continues to light. When a signal for trigger is applied, or when the trigger mode is set to AUTO, the SINGLE processing is performed. Then the LED goes off, and this state is released.
- ③ In case that the TRIGGER MODE switch is set to AUTO, this instrument generates an AUTO TRIG signal periodically to perform the SINGLE processing if this instrument is not triggered by the input signal.
Therefore, a DC signal can also be measured in this mode.

(5) HOLD mode

When the HOLD switch is pressed in the EQUIV, NORM, or ROLL mode, the HOLD mode is set. In this mode, the sampling operation in each operation mode is interrupted, the waveform display data at the time when the mode was changed to the HOLD mode is continued to display. After HOLD, the displayed waveform data can not be moved up and down.

(6) Save operation (SAVE)

The waveform data which is sampled and displayed in the STORAGE MODE can be stored in the save memory.

The data stored in the save memory can be displayed on the CRT by the RECALL operation.

SAVE operation

a) The sampling data is displayed in the STORAGE MODE. When the HOLD switch is pressed, the waveform is held.

b) The held waveform data is stored in the save memory by the following operation. (The SAVE switch functions only in the HOLD mode.)

c) The save switch LED lights momentarily to indicate that the waveform has been saved.

The saved waveform data continues to be saved unless a new waveform data is stored by the above operation.

d) When the VERTICAL MODE switch is set to CH1, CH2 or ADD, each pressing the SAVE memory saves the waveform in the save memories A and B alternately. When the VERTICAL MODE switch is set to DUAL, the CH1 waveform is saved in the save memory A, and at the same time, the CH2 waveform is saved in the save memory B.

(7) Display of the save memory (RECALL)

The contents of the save memory stored by the save operation in the HOLD mode are displayed on the CRT by the following operation, and can be compared with a current waveform.

- ① When the VERTICAL MODE switch is set to CH1, CH2 or ADD Pressing the RECALL switch displays the waveform stored in the save memory A, and the setting values (V/DIV and TIME/DIV).

Further pressing the switch displays the waveform stored in the save memory B. When the switch is pressed again, the save waveform disappear.

- ② When the VERTICAL MODE switch is set to DUAL (CHOP) Pressing the RECALL switch displays the waveform stored in the save memories A and B. When the switch is pressed again, the save waveform disappears.

As the waveform data displayed in the save mode is saved in the save memories, the save waveform can not be moved up or down.

(8) Output to the X-Y plotter (PLOT)

The waveform displayed in the HOLD mode is fed out to the X-Y plotter via the RS-232C by pressing the PLOT switch.

(The PLOT switch functions only in the HOLD mode.)

Press the PLOT switch again to interrupt plotting.

For details, refer to section 9.

(9) Horizontal magnifying display (Magnification of time axis)

A storage waveform displayed on the CRT is magnified by 10 times from the position pointed by the MAG POINT cursor.

a) Move the portion to be magnified to the center of the screen. Use the VARIABLES rotary control to move the portion. The clockwise rotation moves the portion to the right, and the counterclockwise rotation moves it to the left. (H POS LED lights.)

b) When the X10 MAG switch is pressed, the data at 1 div at the center of the screen is magnified by 10 times.

NOTE:

When the initial waveforms of CH1 and CH2 are both displayed, both the waveforms are magnified from the center position.

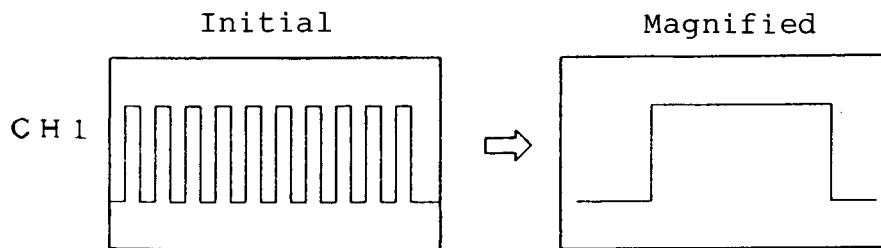

c) Press the X10 MAG switch again. The initial waveform will be displayed.

NOTE:

When the sampling is made in the ROLL mode, the horizontal magnification by the above operation can not be performed.

However, the horizontal magnification in the HOLD state is possible.

(10) Memory back-up function

The instrument has a memory back-up function. Therefore, the waveform data stored in the save memory can be retained for approximately 48 hours after turning off the power of the instrument.

To use this function properly, consider the following note.

NOTE:

To store data for more than 48 hours, it is necessary to charge the memory backup element for more than 10 minutes before turning off the power. To store the SAVE data, be sure to turn on the power for more than 10 minutes, before turning off the power.

(11) MENU mode

The settings of the number of average, the interpolation method in the horizontal magnification mode and the on-off of the waveform smoothing can be made by the MENU switch. Each pressing the MENU switch displays the **AVG**, **INTRPL** and **SMOOTH** at the top right of the CRT in sequence and the LED lights. Further pressing the switch releases the MENU mode and the LED goes off.

Clockwise rotation changes the mode from OFF to LIN to SIN. The interpolation method is how to interpolate the magnified data when magnifying the display waveform in the horizontal direction (except for the save waveform).

In case of OFF, the waveform is magnified as is in the horizontal direction.

In case of SIN, the SIN operation is performed, so that the initial waveform is shaped to be a waveform close to a sine wave. This is effective for a sine wave.

When a square wave is connected in this state, ringing becomes remarkable, and the displayed waveform seems to be different from the input waveform. In this case, change the setting to OFF or LIN.

In case of LIN, data is interpolated linearly, and the waveform is displayed smoother than at OFF.

NOTE:

In case of SIN, set the amplitude of the input signal to less than 8 div on the CRT.

When the signal having a large amplitude on the CRT is connected, waveform distortion is observed at the upper and lower portions of the waveform.

When the interpolation method is changed in the ROLL mode, the ROLL waveform is held and the interpolation becomes effective in the MAG X10 mode. The MAG X10 mode is not valid when the ROLL waveform is not held.

③ Smoothing selection mode

When the MENU LED lights and the SMOOTH is displayed at the top right of the CRT, the smoothing is made on and off.

S M O O T H O F F

OFF: No smoothing
 ON: Smoothing

(13) DLY operation

Partial magnification due to delay sweep can be made by the HORIZONTAL mode switch.

- ① Set the HORIZONTAL mode switch to A and display the waveform.
- ② Set the HORIZONTAL mode switch to ALT. Then the delay time is displayed at the top of the CRT together with the DLY cursors. The distance between the DLY cursors is determined by the TIME/DIV settings of the A and B sweeps. Partial magnification can be set by the VARIABLES control.
- ③ Prior to the TIME/DIV setting change of the A sweep, set the HORIZONTAL mode to A.

NOTE:

Though the DLY cursors can be moved by the VARIABLES control, it is impossible to move them to the left side of the TRG cursors.

When the TRG cursors are moved in the A mode (H.POS) after the DLY cursors have been set in the ALT mode, the positions of the DLY cursors may be changed when the mode is set to ALT again.

8.4 General Measurement

(1) Voltage measurement

① ΔV cursor measurement

The measurable area by the ΔV cursors is 3 divisions above and below the center horizontal graticule line.

Set the VOLTS/DIV switch so that a waveform is within the area. When a signal including a DC component is measured in the DC coupling mode, adjust the POSITION control so that the GND trace is within the measurable area.

When the MEASURE is selected by the SELECTOR, two horizontal cursors appear on the CRT. The voltage between the reference cursor and the Δ cursor is displayed with "V" on the upper side of the CRT. The voltage becomes "+" when the Δ cursor is above the reference cursor, while it is "-" when the Δ cursor is below the reference cursor.

The cursor selected by the CURSORS REF. Δ .TRACKING switch moves up when the VARIABLES control is turned clockwise, while it moves down when the control is turned counter-clockwise. Therefore, the voltage between two cursors can be measured.

To measure the voltage from the GND line, press the GND switch to display the GND line, and align the reference cursor with the GND line. Switch the input coupling mode to DC, and align the Δ cursor with the level to be measured.

ΔV cursor measurement for AC voltage

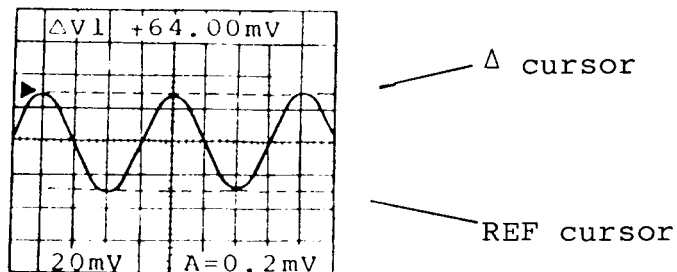

NOTES:

- a) When the DUAL mode is selected in the REAL TIME mode, the measurement value of CH1 ($\Delta V1$) is displayed.
- b) When the HORIZONTAL MODE is X-Y, or when the HORIZONTAL MODE is ALT in the REAL TIME mode, the ΔV cursor can not be selected.
- c) The resolution of the ΔV cursor is 100 points/div in the REAL TIME mode and 25 points/div in the RECALL mode. Consequently, the measured data is slightly different from the REAL TIME mode to the STORAGE mode.

② Visual measurement

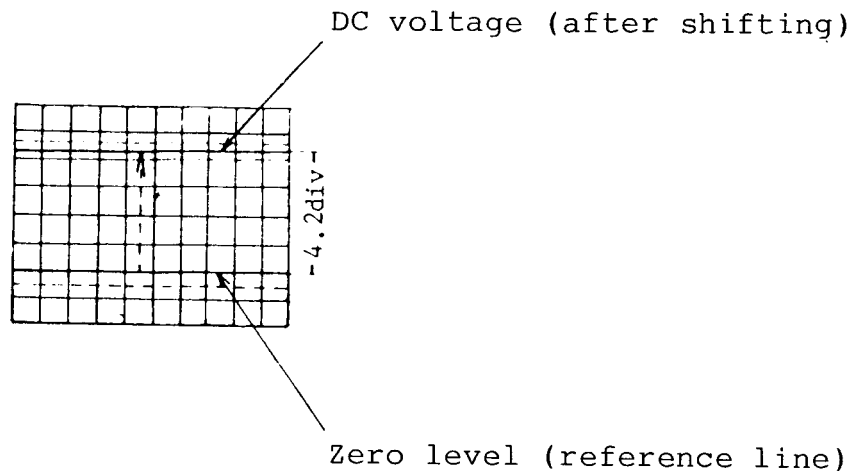

Set the GND switch to GND and obtain the base-line trace. Set the AC-DC switch to DC and set the VOLTS/DIV switch to obtain an optimum amplitude waveform. Since the trace shifts by the amount of DC voltage, the DC voltage of the signal can be obtained by multiplying the shift by the indicated value of VOLTS/DIV. When VOLTS/DIV is 50 mV/DIV, then $50 \text{ mV/DIV} \times 4.2 = 210 \text{ mV}$ (However, if the 10X probe is in use, the true value of the signal becomes 10 times the value, it will be $50 \text{ mV/DIV} \times 4.2 \times 10 = 2.1 \text{ V}$).

(2) Time and frequency measurement

① ΔT cursor measurement

When the **MEASURE** is selected by the SELECTOR, the ΔV cursor appears on the CRT.

Then, when the SELECTOR is moved downward once so that the ΔT cursor measurement mode is established, the measurement value will be displayed with ΔT on the upper side of the CRT.

The measurable area by the ΔT cursor is 4 divisions to each side from the center vertical graticule line.

Set the TIME/DIV switch so that the desired portion of a waveform is as large as possible.

The two cursors selected by the CURSORS REF $\cdot\Delta$ TRACKING switch can be shifted by the VARIABLES control.

The positive or negative polarity corresponds to the two cursor positions;

+: The Δ cursor is located on the right side of the reference cursor.

-: The Δ cursor is located on the left side of the reference cursor.

Clockwise rotation of the VARIABLES control moves the cursor to the right; counterclockwise rotation moves it to the left.

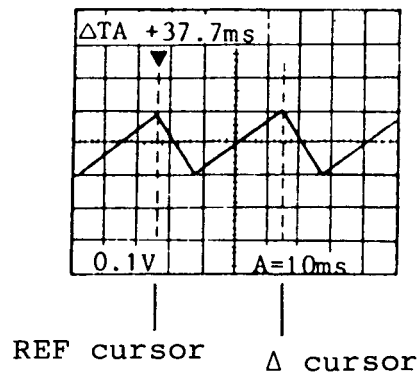

NOTES:

- a) When the HORIZONTAL MODE is X-Y, or when the HORIZONTAL MODE is ALT in the REAL TIME mode, the ΔT cursor measurement can not be selected.
- b) The measurement value is displayed in divisions when the TIME switch and the VARIABLES control function produce an uncalibrated sweep.
(UNCAL state, CRT display:>)

② **1/ ΔT cursor measurement**

When the **MEASURE** is selected by the SELECTOR, two cursors will appear on the CRT. When the SELECTOR is moved down twice, 1/ ΔT is displayed on the upper side of the CRT. When the two cursors are set to the peaks of the waveform corresponding to one period by the VARIABLES control, the reciprocal number of Δ -time between two cursors is displayed with 1/ ΔT on the upper side of the CRT. Clockwise rotation of the VARIABLES control moves the cursor to the right; counterclockwise rotation of the control moves the cursor to the left.

NOTES:

- a) When the HORIZONTAL MODE is X-Y, or when the HORIZONTAL MODE is ALT in the NON STORE mode, the 1/ ΔT cursor measurement cannot be selected.
- b) The measurement value is displayed in divisions when the TIME switch and the VARIABLES control function produce an uncalibrated sweep.
(UNCAL state, CRT display:>)

③ Visual time measurement

The illustration shows one period of time between A and B, which represents 2.0 DIV.

When the sweep time is 1 ms/DIV, the period is given by

$$1 \text{ ms/DIV} \times 2.0 = 2.0 \text{ ms} \\ (2.0 \times 10^{-3} \text{ s})$$

④ Visual frequency measurement

The above result, 2.0 ms ($2.0 \times 10^{-3} \text{ s}$), is converted so that the frequency is given by

$$1/(2.0 \times 10^{-3}) = 500 \text{ Hz.}$$

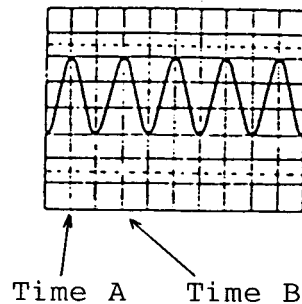

(3) How to trigger

(a) Operation of the AUTO trigger function

When the TRIGGER MODE switch is set to AUTO, the instrument automatically displays a sweep if an input signal is not applied.

The trigger level is set according to the amplitude of input signal as shown in Figs. (a) and (b).

The AUTO TRIGGER LEVEL setting function eliminates troublesome triggering.

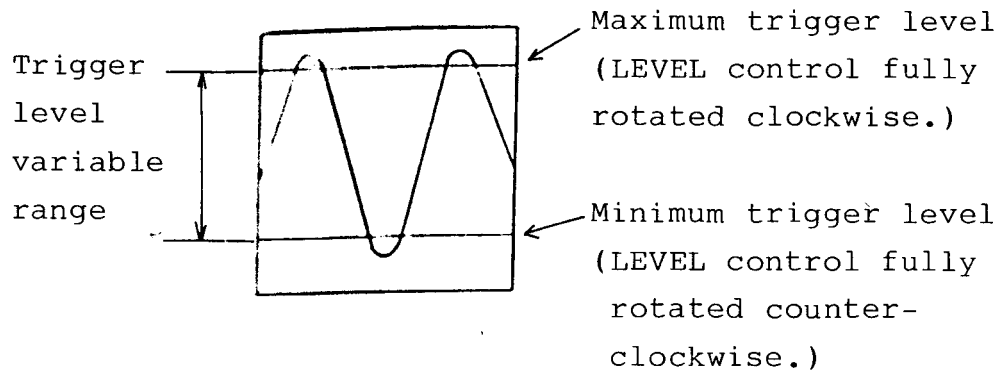

(a) Input signal of large amplitude

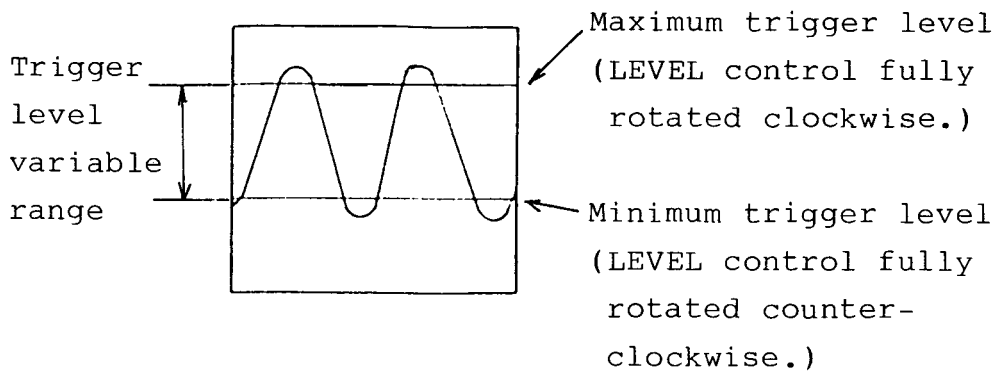

(b) Input signal of small amplitude

When the TRIGGER MODE rotary switch is set to NORM, the trigger level is set regardless of the input signal level.

NOTE:

When the TRIGGER MODE rotary switch is set to AUTO, it takes 2 or 3 seconds to obtain a stable trigger since the trigger level is automatically set according to the amplitude of an input signal.

(b) Operation of the TRIGGER LEVEL control

In the case shown in Fig. (a) where waveforms are greatly different in amplitude, the waveform is doubled if the TRIGGER LEVEL control is not set properly. In the case where the trigger level is selected by line Y, two waves, one starting with A, advancing to B, C, D, E, F,... and the other starting with E, advancing to F, G, H, I..., will appear alternately on the screen. They will be doubled as shown in Fig. (b).

In such a case, rotate the LEVEL control clockwise until the trigger level comes to Y' line. Then the waveform on the screen becomes the one as shown in Fig. (c) which starts with B and advances to C, D, E, F,... and allows triggering.

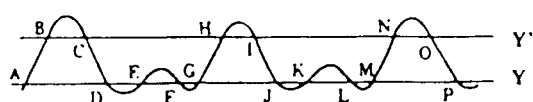

Y' Trigger level
Y setting line

(a) Signal waveform



(b) When the trigger setting level is Y



(c) When the trigger setting level is Y'

Triggering of complex waveforms

(c) Operation of the HOLDOFF function

① In case of measuring a high frequency signal

Slight jitter may occur on a high frequency signal of approximately 5 MHz or more. In this case, adjust the HOLDOFF control so that the jitter is eliminated and a stable trigger is obtained.

② In case of measuring a complex waveform as shown in (a)

It is possible that the triggering is doubled as shown in (b) by the TRIGGER LEVEL control. In such a case, light the **HOLDOFF** by the SELECTOR and adjust the VARIABLES control to obtain the proper waveform as shown in (c).

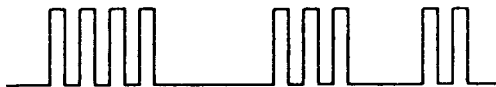

(a) Signal waveform



(b) Before using
HOLDOFF



(c) After using
HOLDOFF

Triggering of complex waveforms

(d) Operation of the TRIGGER LOCK function

Triggering can be doubled when the sweep range is changed after performing the HOLDOFF adjustment.

In such a case, light the HOLDOFF by the SELECTOR.

When the TRIGGER LOCK lamp is lit with the waveform triggered, the triggering is not doubled if the sweep range is changed.

If the TRIGGER LOCK function is not required, press the TRIGGER LOCK switch again so that the lamp goes off and this function is released.

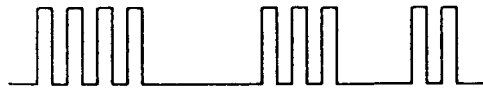

(a) Waveform triggered by HOLDOFF, etc.

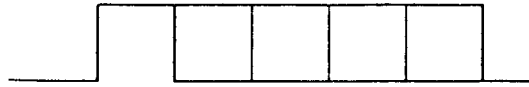

(b) Magnified with TRIGGER LOCK OFF

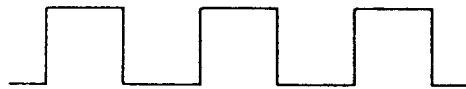

(c) Magnified with TRIGGER LOCK ON

Triggering of complex waveforms

NOTE:

The A TIME/DIV range and the TIME VARIABLES range in the TRIGGER LOCK mode cannot be set to the slower than that when the signal is locked.

(e) Operation of the TV trigger SYNC function

① TV video signal

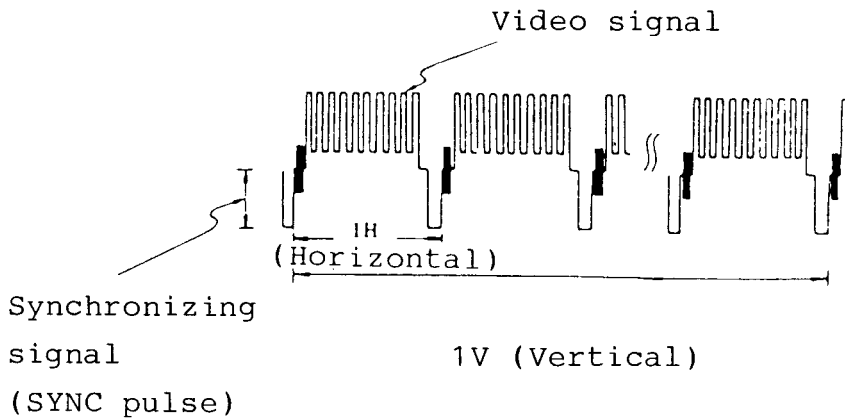

In video work, a composite video signal containing a video signal, a blanking signal, a pedestal signal, and a sync signal is often measured.

② Operation

To observe a vertical signal

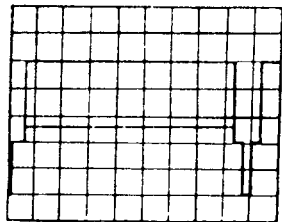

TRIGGER MODE: TV-V

To observe a horizontal signal

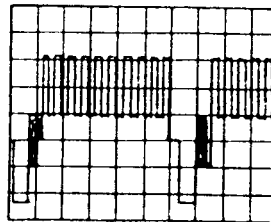

TRIGGER MODE: TV-H

The polarities of the video and sync signals are automatically set. The trigger level setting is not required in the TV mode.

**(4) Measurement of the waveform before the trigger point
(PRETRIGGER)**

Although a conventional oscilloscope displays the trigger point only at the left end of the screen since the sweep starts at the trigger point of the signal, the instrument can display the trigger point anywhere on the screen in 0.1 div steps, using the PRETRIGGER function in the STORAGE mode so that it is possible to measure the waveform before trigger point precisely.

- (a) When the H.POS lamp is selected by the SELECTOR switch, the position of the trigger point is displayed (div).
- (b) The position of the trigger point is set by the VARIABLES control.
- (c) Example:

In the case of 4.0 div setting, the signal before the rising edge of the waveform (the triggered point) can be observed as shown below.

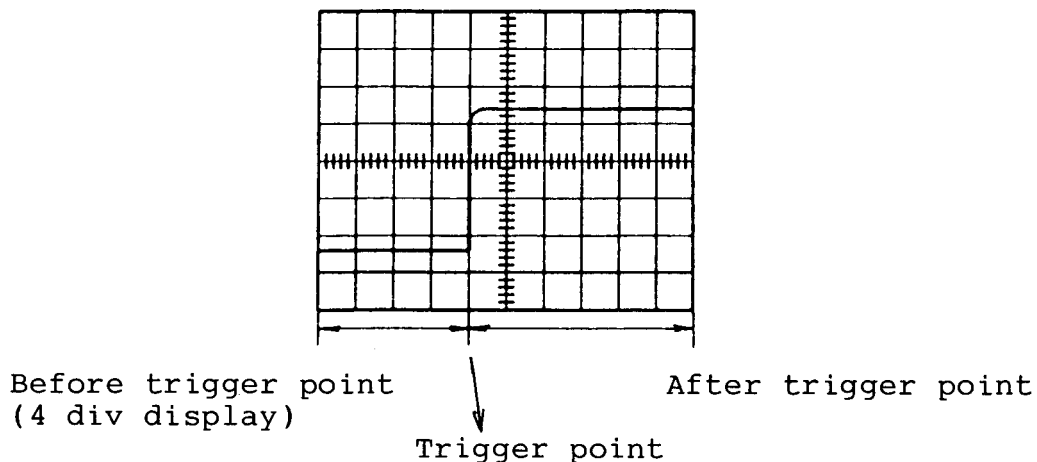

(5) Operation of the AUTO range function

In the normal measurement, the sweep range is set by the TIME/DIV switch. When the AUTO lamp is lit by pressing the AUTO switch with the signal triggered, the input signal is detected, the sweep range is automatically set, and the waveform of 1.6 to 4 cycles is displayed on the CRT. This is recommended when the time relation of an input signal is unknown or the input frequency changes with time.

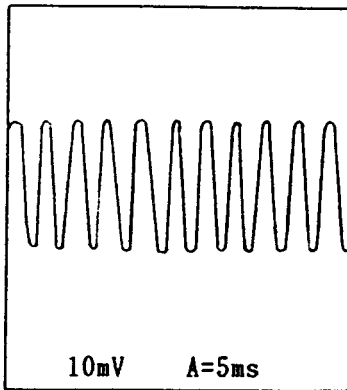

(a) Before using AUTO range

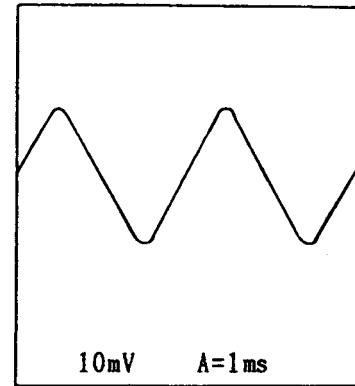

(b) After using AUTO range

NOTES:

- a) The AUTO range does not function when the trigger is not obtained. The AUTO range functions with the trigger signal selected by the TRIGGER SOURCE OR X and TRIGGER MODE switches.
- b) Since the operable time range is 5 ms/DIV to 50 ns/DIV, the signal of 100 Hz or less, or 8 MHz or more is not displayed as the waveform of 1.6 to 4 cycles. The time range is set to 5 ms/DIV for the signal of 100 Hz or less or in case of out of trigger, and set to 50 ns/DIV (maximum) for the signal of approximately 8 MHz or more.
- c) The HORIZONTAL MODE switch should be set to A.

- d) When the AUTO range functions with the VERTICAL MODE switch set to DUAL, the dual trace operation is always performed in the CHOP mode. For measuring the waveforms at high speed, release the AUTO range function by setting the A AND B TIME/ DIV switch to the high speed mode or the low speed mode.
- e) In case of measuring a complex waveform such as a TV signal, it may take several seconds to perform the AUTO range function.
- f) In case of measuring a complex waveform, the time range can be automatically changed and the waveform cannot be measured easily. In this case, release the AUTO range function.
- g) To release the AUTO range, set the A AND B TIME/DIV switch to either side.
- h) In the X10 MAG mode, the waveforms of 1.6 to 4 cycles are magnified by 10 times.

(6) Operating procedure of the delayed sweep

① REAL TIME mode

A delayed sweep is used to magnify any portion of a complex waveform in the horizontal direction.

Press the A switch of the HORIZONTAL MODE to trigger the A sweep and set the switches as follows.

HORIZONTAL MODE : ALT

A TIME/DIV : As desired

B TIME/DIV : Set to the time range to be magnified.

A and B sweeps appear simultaneously on the CRT, DELAY is automatically set by the SELECTOR, and the two cursors will appear.

The two cursors will move continuously by the VARIABLES control. Bring the cursors to the position to be magnified. Then, the waveform between the cursors is magnified to occupy the full area of the screen.

The time from a starting point of the A sweep to that of the B sweep is displayed on the upper left side of the CRT. To measure the magnified waveform only, set the HORIZONTAL MODE to B.

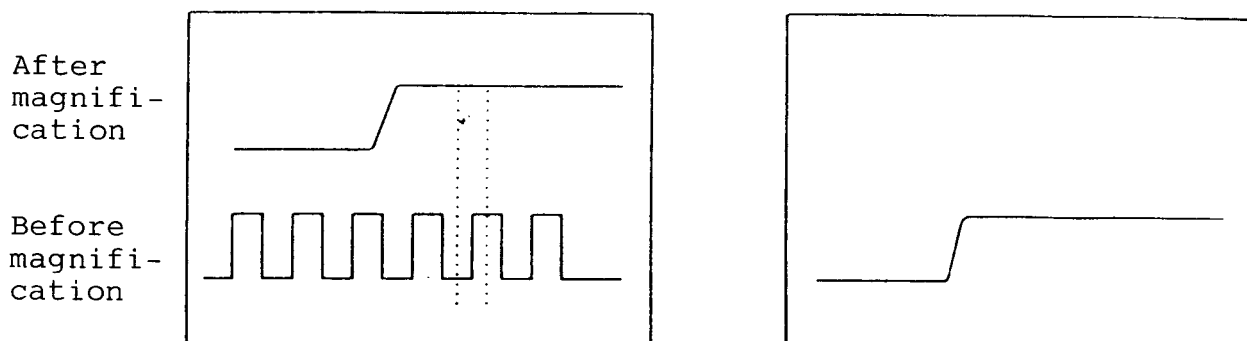

(a) HORIZONTAL MODE: ALT

(b) HORIZONTAL MODE: B

The B sweep trace can be shifted vertically approximately ± 3 divisions with respect to the A sweep trace for the convenience of measurement by the A/B SEP switch. The vertical variable range is initialized to approximately +2 divisions with respect to the A sweep trace. By setting the VERTICAL MODE to the dual mode in the ALT sweep mode, two more traces, four traces in total, appear on the CRT.

NOTES:

- a) Since traces are alternately displayed in the ALT sweep mode, flicker can occur in the slow sweep rate. To avoid this, set the TIME/DIV switch to the 0.2 ms/DIV or higher.

- b) The time range of the B sweep is designed to be always higher than that of the A sweep (except in the 50 ns/DIV). Prior to change of the time range of the A sweep with the HORIZONTAL MODE switch set at ALT or B, set the HORIZONTAL MODE to A again.

- c) As the magnification ratio increases in the delay sweep mode, the intensity decreases. If the focus of the trace is adjusted to be optimum at this time, a proper focus cannot be obtained for characters, which is not suitable for photographing. Therefore, do not increase the intensity too much, or blank characters for photographing.

- d) The interval between two cursors in the delay sweep mode is designed to be always 0.5 div or more on the CRT, so that easy observation is ensured when the magnification ratio is increased.
Therefore, all the waveform between the cursors is not magnified when the magnification ratio is increased. To verify what part of the A sweep is magnified, check the delay time displayed on the upper left side of the CRT and the A sweep time.

- e) The cursors which indicate delay position disappear when the X10 MAG mode is established.

② STORAGE mode

This mode is used for sampling the portion of a signal delayed by a certain time from the trigger point of the A sweep at a high speed and measuring the signal precisely.

Select the A switch of the HORIZONTAL MODE and trigger the signal and set the TIME/DIV switch as follows.

A TIME/DIV : Set this control so that the delay time is within 10 divisions on the CRT.

For example, if the delay time is 8 ms, set this control at a slower range than 1 ms/DIV.

Then, set the HORIZONTAL MODE to B, and the SELECTOR is automatically set to DELAY. The waveform is changed to the B sweep waveform and the TIME/DIV display is changed to B TIME/DIV.

- a) Set the delay time displayed at the upper left side of the CRT to the desired value by the VARIABLES control. The waveform start point at the left side of the screen is delayed by the set time from the trigger point of the A sweep.
- b) Set the B TIME/DIV to the time range to be measured.

NOTES:

- a) The B sweep can be set for the time range of 2.5 μ s/DIV to 50 ms/DIV (5 μ s/DIV to 50 ms/DIV for the VC-6025) in the NORM or the AVG mode, and 0.1 ms/DIV to 50 ms/DIV in the ENV mode.
- b) As in the NON STORE mode, the B sweep time range is not made slower than the A sweep time. When the HORIZONTAL MODE is set to B, the A TIME/DIV can not be changed. When changing the time range of the A sweep, reset the HORIZONTAL MODE switch to A.
- c) When the PRETRIGGER is set in the B sweep mode, the time from the trigger point of the A sweep to the PRETRIGGER corresponds to the delay time set previously.

(7) Measurement of single shot phenomena

To measure a single-shot signal and a complex waveform such as an impulse wave, an audio signal, noise from a switch, etc., the STORAGE mode is usually used. However, the following measurement is sometimes possible in the REAL TIME mode.

① Single sweep measurement for a waveform to be easily triggered

Set the HORIZONTAL MODE to A, and the TRIGGER MODE to NORM. Connect a vertical signal to be observed or a repetitive waveform having the same amplitude as the above signal, and rotate the TRIGGER LEVEL control to obtain a proper triggering.

Select SINGLE by the SELECTOR, press the SINGLE RESET switch, and check that the single sweep is performed. Disconnect the vertical signal from the instrument (press the GND switch, for example), press the SINGLE RESET switch again, and check that the SINGLE RESET lamp lights. When the vertical signal is connected again, the single sweep is performed. At the time, the SINGLE RESET lamp goes off.

② Single sweep measurement for a waveform hard to be triggered

Set the TRIGGER MODE to AUTO, the HORIZONTAL MODE to A, and select SINGLE by the SELECTOR.

Press the SINGLE RESET switch so that the single sweep is performed.

NOTES:

- a) If the TRIGGER LEVEL control is rotated, the sweep is performed even when no signal is supplied. After the SINGLE RESET lamp lights, do not rotate the TRIGGER LEVEL control.

- b) For a general single shot measurement, set the TRIGGER MODE to NORM.
- c) When the HORIZONTAL MODE is set to ALT or B, the single sweep cannot be performed.

**(8) Operation of the BW LIMIT function
(only valid for a trigger signal in the STORAGE mode)**

When it is hard to measure or trigger a signal because a high-frequency component of more than 20 MHz (more than 10 MHz for the VC-6025) is superimposed on the signal, use the BW LIMIT function.

By the BW LIMIT function, the component of approximately 20 MHz or more of the sync signal can be eliminated.

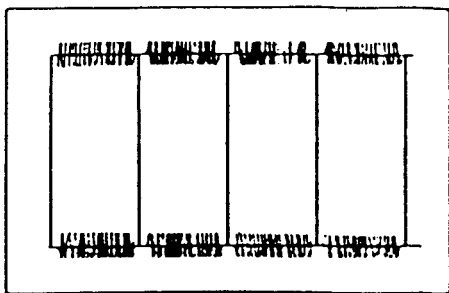

(a) Before the BW LIMIT functions

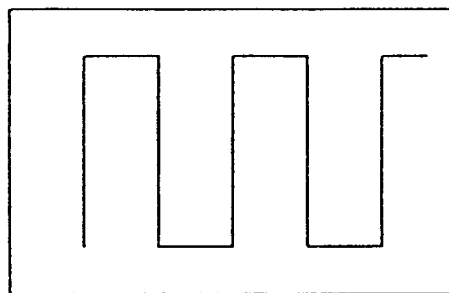

(b) After the BW LIMIT functions

NOTE:

When the BW LIMIT function is used, the frequency bandwidth is approximately 20 MHz (10 MHz for the VC-6025).

(9) System reset

In case of abnormal AC power, etc., the built-in microprocessor can malfunction. In this case, press the POWER switch to OFF, and then ON after three seconds or more to reset the microprocessor. Allow approximately twenty seconds for the instrument to be operated after completion of the automatic calibration.

9. DIGITAL PLOT OUTPUT TO THE X-Y PLOTTER

All the data displayed on the screen is output to the X-Y plotter only by connecting this instrument and the X-Y plotter with the RS-232C cable.

The operation of the instrument is described below.

For the operation of the X-Y plotter, refer to the operation manual attached to the plotter.

9.1 Applicable X-Y Plotter

Hitachi Graphic Plotter 672-XD (RS-232C specifications) or completely compatible unit.

9.2 Specifications of Plot

(1) Letters and cursor

All the letters and cursor displayed on the screen are plotted.

(2) Waveform data

All the waveform data displayed on the screen is plotted. The waveforms of the horizontal axis of 10 divisions and the vertical axis of 10 divisions are plotted.

In the magnification mode, the magnified portion only is plotted.

(3) Grids and scale

The grids of the horizontal axis of 10 divisions and the vertical axis of 8 divisions are plotted. The scale of 0.2 div unit on the horizontal and vertical center grids is plotted.

(4) Screen mode

The four screen modes are selectable by setting the DIP switches on the rear.

For details, refer to item 9.4 Setting.

(5) Pen replacement

Replacement of pens can be designated by the DIP switches the rear. For details, refer to item 9.4 Setting.

(6) Examples of plot

Figs. 9-1(a) thru 9-1(d) illustrate examples of the plot output.

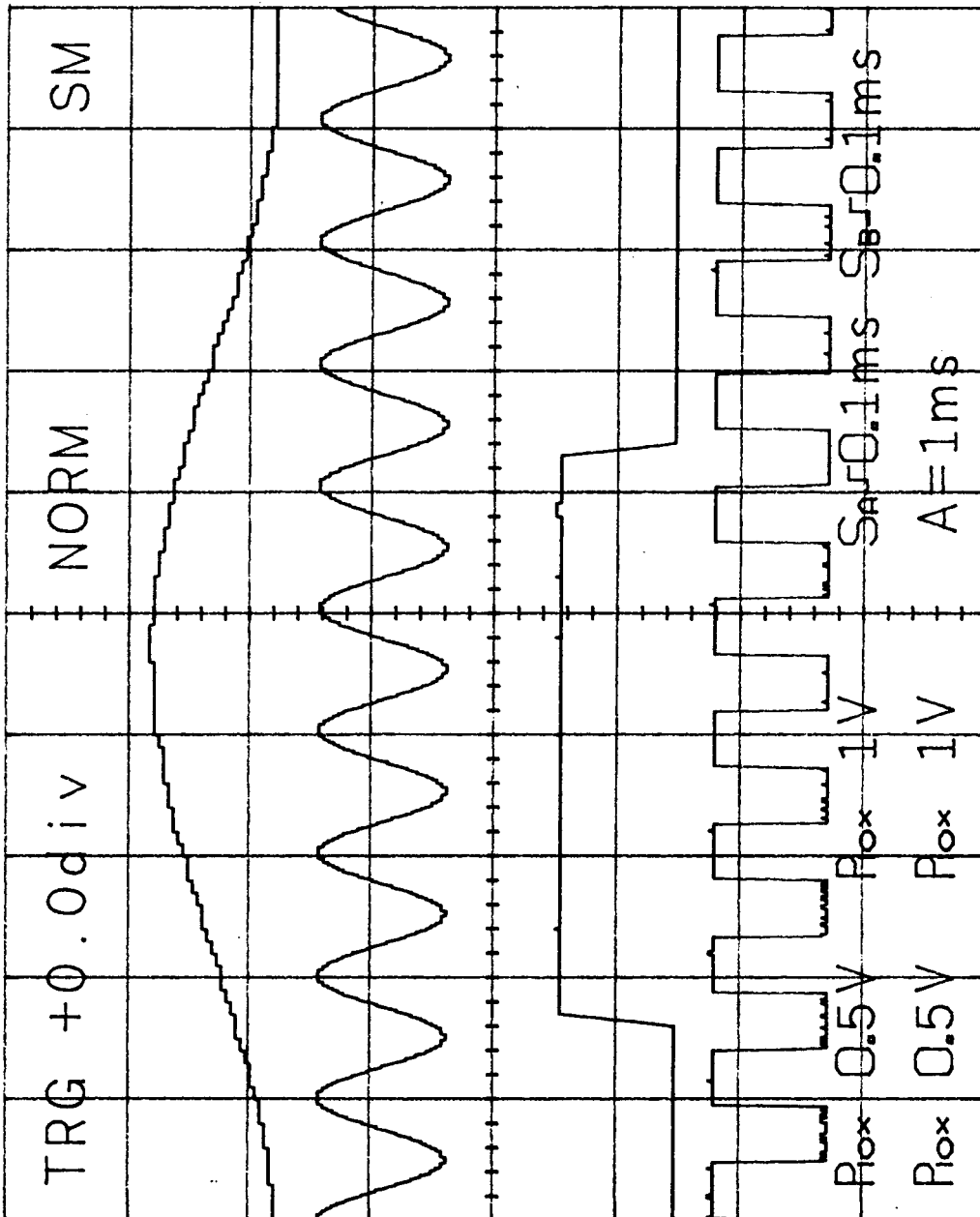

Fig. 9-1(a) Plot output display 1

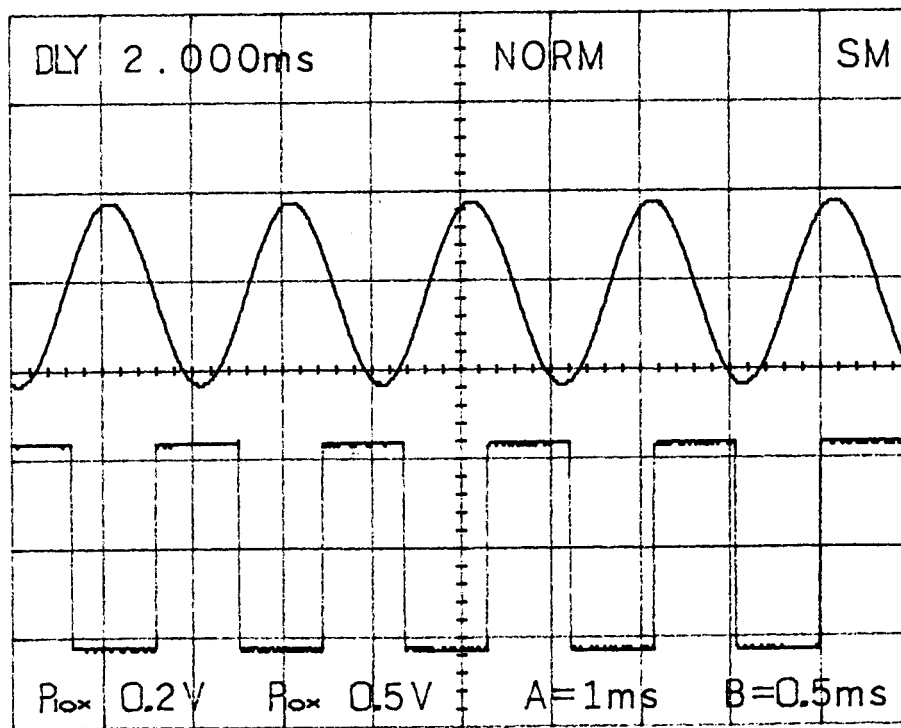
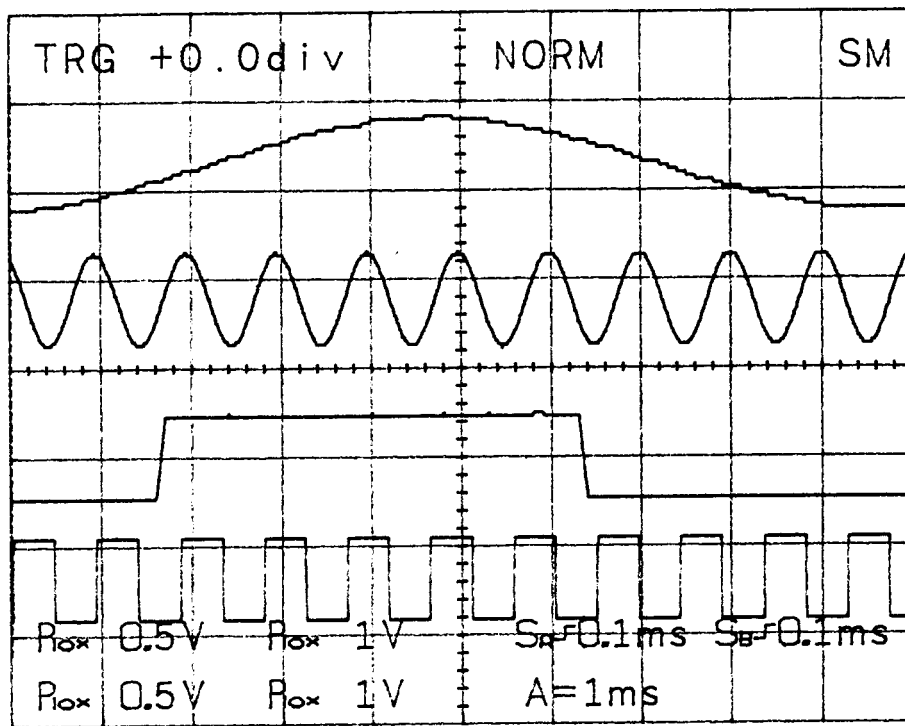

Fig. 9-1 (b) Plot output display 2

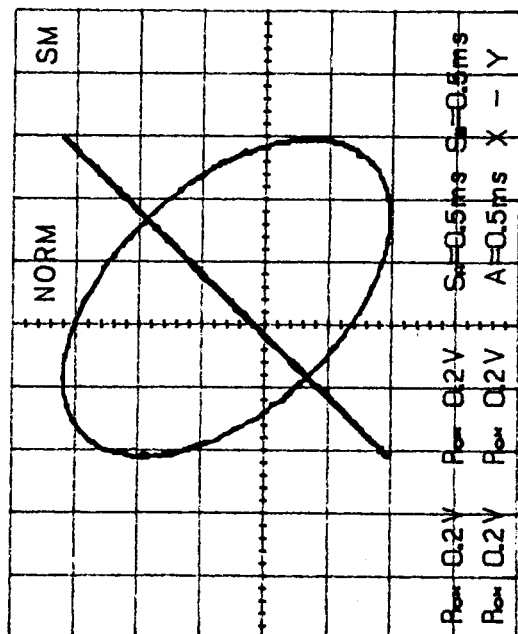
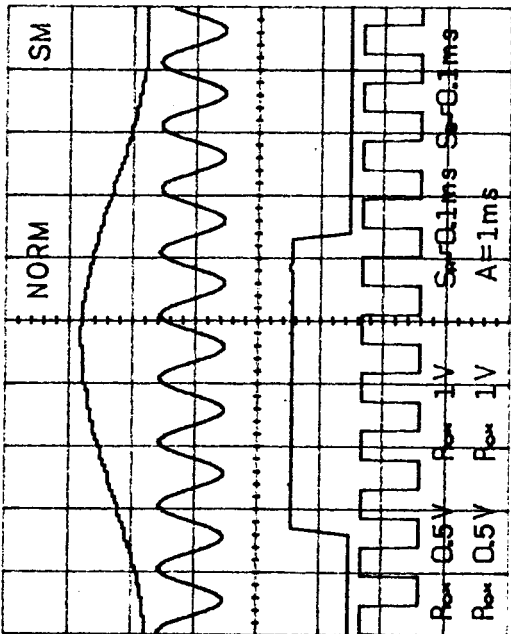
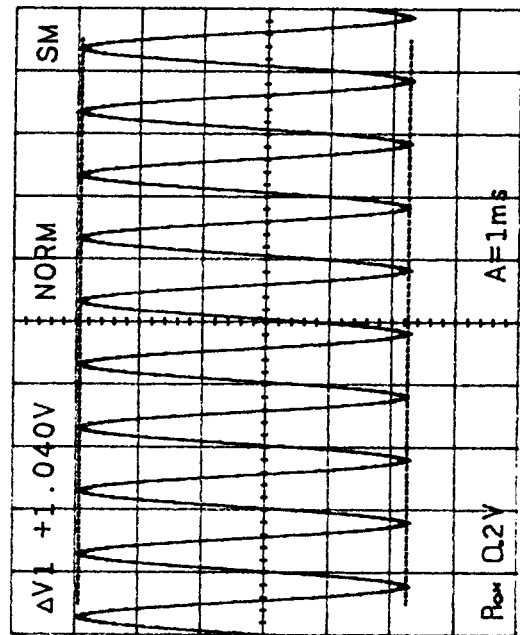
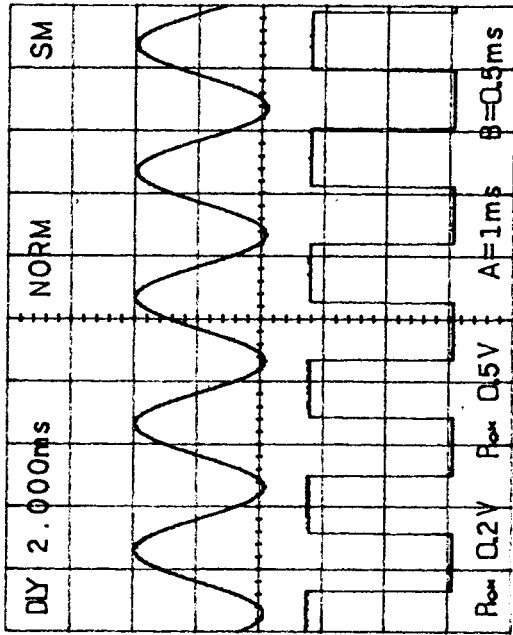

Fig. 9-1 (c) Plot output display 3

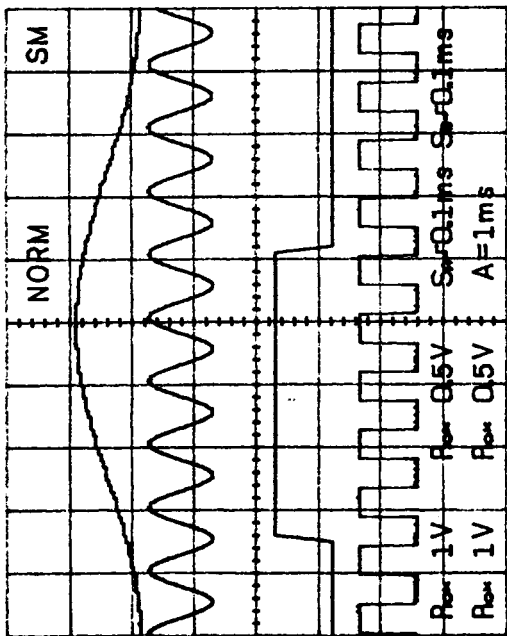
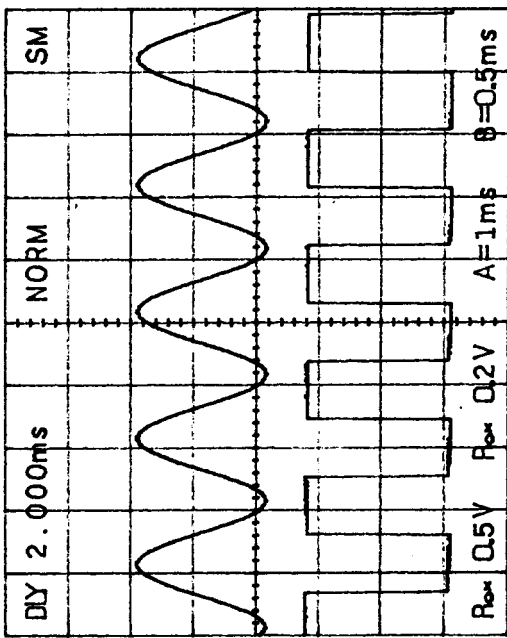

Fig. 9-1 (d) Plot output display 4

9.3 Connection

Connect the connector on the rear with a X-Y plotter by the RS-232C interface cable.

Prior to connection of a plotter, read the related manual carefully and use the appropriate interface cable, because interface is changed in accordance with types of plotter.

Fig. 9-2 illustrates the wiring of the RS-232C interface cable used for the connection of the Hitachi Graph Plotter 672-XD and the instrument.

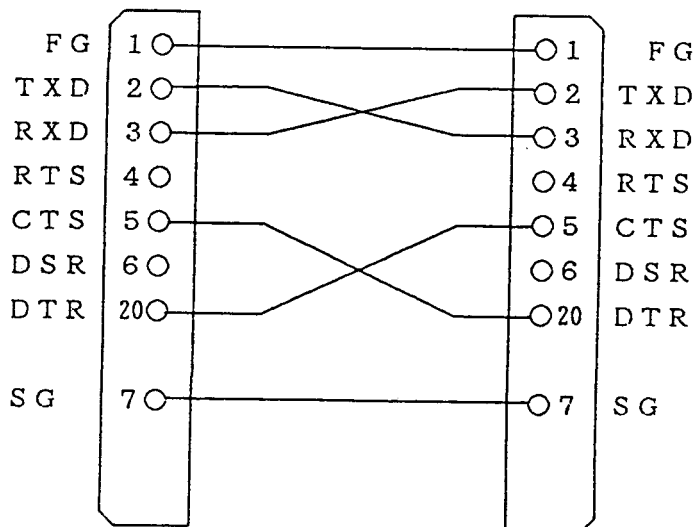
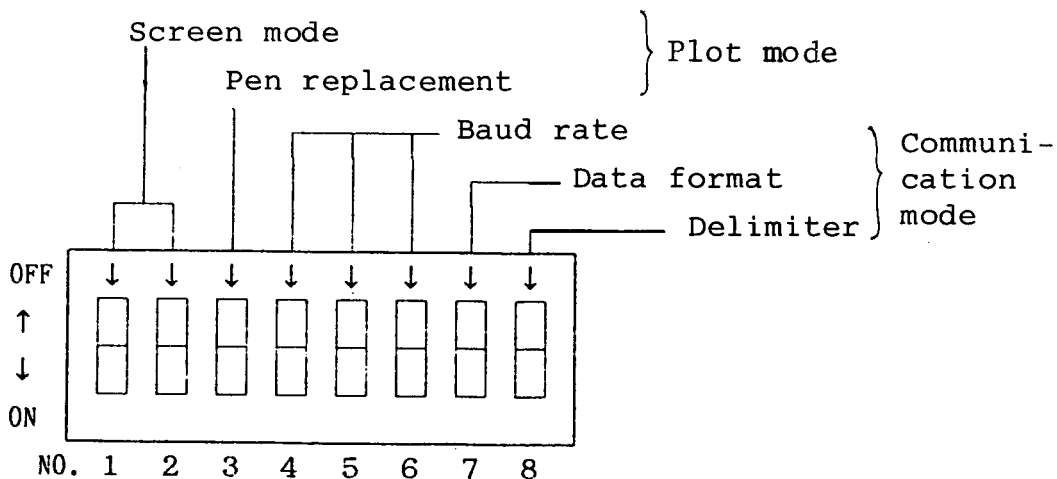

Fig. 9-2 Wiring diagram of the RS-232C interface cable

9.4 Setting

Set the plot mode and the communication mode by the DIP switches on the rear.



(1) Plot mode

(a) Screen mode setting

The screen size can be set by Nos. 1 and 2 of the DIP switches, and one of the modes listed in Table 9-1 is selected.

Table 9-1. Screen mode setting

Screen mode	DIP switches		Content	Screen size (mm)
	No.1	No.2		
1	ON	ON	One screen is plotted on a sheet of A4 size paper.	170 x 170 (Refer to Fig. 9-1 (a).)
2	ON	OFF	Two screens are plotted on a sheet of A4 size paper.	120.8 x 120.8 (Refer to Fig. 9-1 (b).)
3	OFF	ON	Four screens are plotted on a sheet of A4 size paper.	85 x 85 (Refer to Fig. 9-1 (c).)
4	OFF	OFF	Two screens are plotted on a sheet of A4 size paper.	85 x 85 (Refer to Fig. 9-1 (d).)

(b) Pen replacement setting

The pen replacement can be set as listed in Table 9-2 by No. 3 of the DIP switches.

Table 9-2 Pen replacement setting

DIP switches	Pen replacement
No.3	
ON	No
OFF	Yes

When No. 3 of the DIP switches is OFF, six kinds of colors can be used for the contents of plot.

Table 9-3 lists the contents of plot and the corresponding pen numbers.

For the plotter whose usable pens are five or less, the corresponding pen numbers are different. In case of the Hitachi graph plotter 672-XD, the pen numbers are listed in parentheses.

Table 9-3 Contents of plot and corresponding pen numbers

Contents of plot		Pen No.	
Grid and scale		1	
Waveform	CH1	3	
	CH2	4	
	SAVE A	5(1)	
	SAVE B	6(2)	
Cursor		2	
Characters	VOLTS/ DIV	CH1	3
		CH2	4
		SAVE A	5(1)
		SAVE B	6(2)
	Time range	A sweep	1
		B sweep	1
		SAVE A	5(1)
		SAVE B	6(2)
	Others		1

(2) Communication mode

Set the baud rate and the data format according to the specifications and applications of the plotter.

The same baud rate and data format must be set to the instrument and the plotter.

(a) Baud rate setting

The baud rate of the RS-232C interface can be set as listed in Table 9-4 by Nos. 4-6 of the DIP switches.

Table 9-4 Baud rate setting

DIP switches			Baud rate
No. 4	No. 5	No. 6	
ON	ON	ON	300 baud
ON	ON	OFF	600 baud
ON	OFF	ON	1200 baud
ON	OFF	OFF	2400 baud
OFF	ON	ON	4800 baud
OFF	ON	OFF	9600 baud
OFF	OFF	ON	"
OFF	OFF	OFF	"

(b) Data format setting

The data format of the RS-232C can be set as illustrated in Table 9-5 by No. 7 of the DIP switches.

Table 9-5 Data format setting

DIP switches	Data format
No. 7	
ON	START BIT + 8BIT + 1STOP BIT
OFF	START BIT + 8BIT + 2STOP BIT

(c) Setting of delimiters

The delimiters needed for the data transfer with the personal computer through the RS-232C can be set, as listed in Table 9-6, by changing the No.8 of the DIP switches. As the delimiters are not added in the digital plot output mode, this setting is not needed.

Table 9-6 Setting of delimiters

DIP switches	Delimiters
No. 8	
ON	C/R L/F
OFF	C/R

NOTE:

As for the communication mode setting, check the settings of the DIP switches before turning on the instrument.

When changing the settings of the DIP switches for the communication mode, change the settings first and then turn on the instrument.

9.5 Operation**(1) Execution of plotting**

When the instrument is in the HOLD mode, press the PLOT switch. Then, the plotting starts immediately. While the plotting is being executed, the red lamp lights.

When the plotting finishes, the lamp goes off and the pen is released.

(2) Release of plotting operation

When the PLOT switch is pressed again during the plotting operation, the plotting operation stops.

Thus an unnecessary plotting operation can be stopped.

9.6 RS-232C Interface

The instrument is provided with the RS-232C as a standard function. With this function, it is possible to perform the control by a personal computer, and input and output the waveform data to the computer. These communication functions can not be used with the output function to the XY plotter.

Do not execute the X-Y plotter output function (plot output by the PLOT switch) when using the communication function.

9.7 Major Causes of Troubles

When the X-Y plotter does not operate normally, check the above items.

- (1) Cable is poorly connected or not connected.
- (2) The power of the X-Y plotter is off.
- (3) The X-Y plotter is not in the LISTEN ONLY mode, or in the error state. (See the operation manual of the X-Y plotter.)
- (4) The instrument is not in the HOLD mode.
- (5) The baud rate and data format are not set correctly. (Turn off the power and set them correctly. See item 9.4 (2).)
- (6) The interface cable in use is not correct. (See item 9.3.)
- (7) Notes on plot interruption

To prevent a possible mis-operation of the plotter, the instrument transmits the initialize commands ("ESC.K", "ESC.R") of the X-Y plotter prior to the start of plot. When the plotter which does not accept these commands is used, mis-operation may be caused. If plotting is interrupted, turn off the X-Y plotter, and then turn on it to initialize the plotter. Thus proceed the plot.

10. RS-232C

10.1 General

The RS-232C is the serial communication interface standardized by the Electronic Industries Association in the United States of America. This instrument can transmit and receive digital data through the RS-232C interface.

10.2 Specifications

- (1) Electrical: Conforms to the EIA RS-232C.
- (2) Type of transmission: Asynchronous
- (3) Length of stop bit: 1 bit/2 bits
- (4) Character length: 8 bits
- (5) Parity bit: Inhibit
- (6) Delimiter: C/R L/F or C/R
- (7) Transmission rate: 300, 600, 1200, 2400, 4800 or 9600 baud
- (8) Communication protocol: Hard wired handshake

10.3 Connector Pin Arrangement and Signal Description

- (1) Fig. 10-1 illustrates the pin arrangement of the RS-232C connector, and Table 10-1 lists the pin functions.

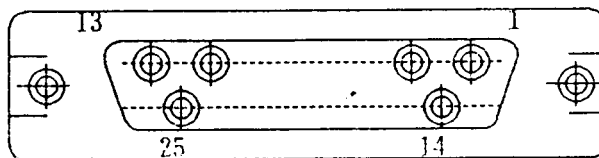

Fig. 10-1 Pin arrangement

NOTE:

Connector DB-25P (female) applicable for connection cable is used.

Table 10-1 Terminals of the RS-232C connector

Pin No.	Signal	Function	Direction of signal
1	FG (AA)	Frame Gnd	
2	$\overline{\text{TXD}}$ (BA)	Transmit Data	OUT
3	$\overline{\text{RXD}}$ (BB)	Receive Data	IN
4	RTS (CA)	Request To Send	OUT
5	CTS (CB)	Clear To Send	IN
6	NC	Non Connect	
7	SG (AB)	Signal Gnd	
8	NC	Non Connect	
9	"	"	
10	"	"	
11	"	"	
12	"	"	
13	"	"	
14	"	"	
15	"	"	
16	"	"	
17	"	"	
18	"	"	
19	"	"	
20	"	"	
21	"	"	
22	"	"	
23	"	"	
24	"	"	
25	NC	Non connect	

(2) Each signal of the RS-232C interface is described below.

- ① FG: Frame Ground
Ground line for chassis
- ② $\overline{\text{TXD}}$: Transmit Data
Transmit data output signal
Normally in the mark state *1
*1 +9 V level ----- "0" (space)
-9 V level ----- "1" (mark)
- ③ $\overline{\text{RXD}}$: Receive Data
Receive data input signal
Normally in the mark state *1
- ④ RTS: Request To Send
This output signal indicates the request-to-send state.
This signal is used to control the transmission function of data transfer at the modem transmission section.
"0" (space): Carrier transmission request
"1" (mark): Carrier stop request
- ⑤ CTS: Clear To Send
This input signal controls the modem transmission section
This signal becomes in the mark state when the modem transmission section is in the Clear-To-Send state.
- ⑦ SG: Signal Ground
Ground line for signal

10.4 Connection

Connect the instrument with a personal computer by the RS-232C interface cable. Prior to connection of a personal computer, read the related manual carefully and use the appropriate interface cable, because interface is changed in accordance with types of personal computers.

Fig. 10-2 illustrates the wiring of the RS-232C interface cable used for the connection of the Hitachi personal computer B-16 and the instrument.

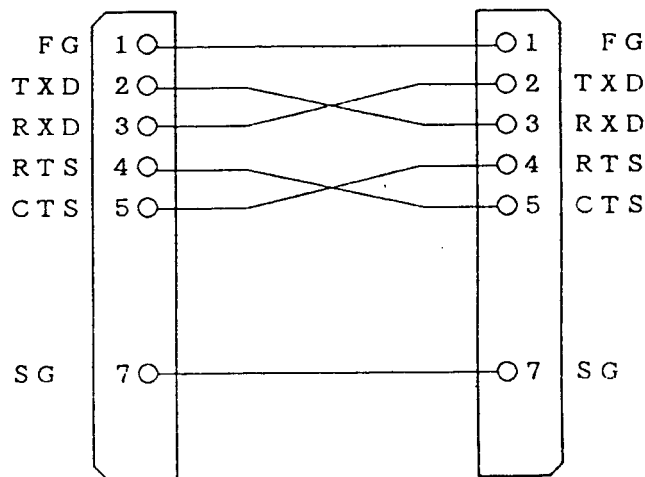

Fig. 10-2 Wiring diagram of the RS-232C interface cable

10.5 Operating Functions and Function Commands

Various operations can be performed under an appropriate program on a personal computer when the instrument is connected with the personal computer, using the RS-232C interface.

Function commands are the commands which designate operations to be executed by the instrument from the program. A highly versatile automatic measuring system can be constituted by programming the operations in sequence at the personal computer.

Functions and function commands available through the RS-232C are described below.

(1) Panel setting

To operate the instrument from the personal computer, set the instrument to the STORAGE mode and the HOLD state. Check that the STORAGE mode setting switch LED and the HOLD LED on the front panel are lit.

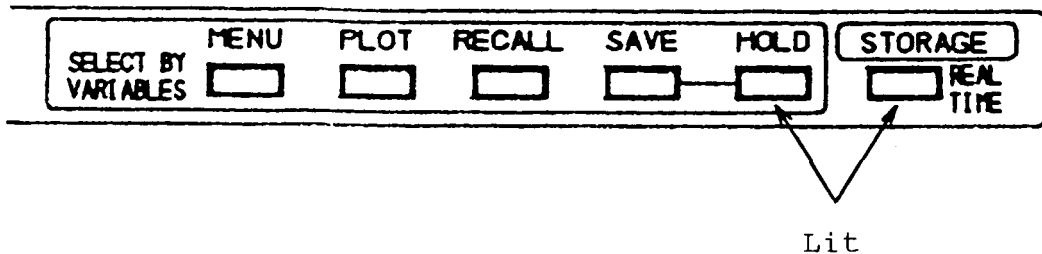

(2) Operating functions

① Sampling start function

The controller can start the following sampling operation.

The single operation of the normal sampling is performed only once. However, the single operation is not performed in the ROLL mode. When receiving this command, the instrument makes the normal sampling of the waveform data equivalent to the data of one whole picture.

When all the data is prepared, the waveform on the CRT is updated and the instrument returns to the HOLD state.

Also, the sampled waveform data acquired by the above procedure can be transferred to the controller using the waveform data transmitting function ③.

② Sweep range setting function

Sweep range can be set when sampling a signal with the sampling start function ①.

When the HORIZONTAL MODE is set to A or ALT, the time range is set as the data of the A sweep range. When the HORIZONTAL MODE is set to B, the time range is set as the data of the B sweep range.

After completion of the sweep range setting, the A sweep range must be greater than the B sweep range. When data out of this relationship is transmitted, the relationship of the sweep ranges are automatically corrected at the main unit side.

After completion of the sweep range setting, the A sweep range must be greater than the B sweep range. When data out of this relationship is transmitted, the relationship of the sweep ranges are automatically corrected at the main unit side.

③ **Waveform data transmission function**

The instrument has the following six data memories:

CH1 acquisition memory which stores the CH1 waveform data

CH2 acquisition memory which stores the CH2 waveform data

Two save memories (SAVE A and SAVE B)

CH1 display memory

CH2 display memory

Each of the CH1 and CH2 acquisition memories has the capacity of loading 1000, 2000 or 4000 data in accordance with the sample mode. Each of the two save memories, and CH1 and CH2 display memories has the capacity of loading 1000 data.

The waveform data can be transmitted to the personal computer from any of these memories. The data in the CH1 and CH2 acquisition memories can not be read in the average mode. The acquisition memory which is invalid in the HOLD mode, eq. the CH2 acquisition memory at the time when the VERTICAL MODE switch is set to CH1, can not be read.

Table 10-2 Sampling mode and acquisition memory capacity

Input mode	Sample mode	Acquisition memory capacity
V MODE = DUAL or H MODE = X-Y	ROLL(Note 1)	2000
	NORM	2000
	EQUIV	1000
Other than above	ROLL	4000(2000) (Note 2)
	NORM	4000(2000) (Note 2)
	EQUIV	1000

Note 1: Average is not executed in the ROLL mode.

Note 2: The figures in parentheses are applied to the VC-6025.

The number of the data which is transferred at one time can be selected appropriately within the range of the memory capacity. Either the decimal ASCII system or the binary system can be selected as the data transfer format.

The waveform data of each memory is 8 bits, i.e., 0 to 255 for the decimal system and $(00)_{16}$ to $(FF)_{16}$ for the hexadecimal system. These data ranges correspond to 10 vertical divisions of the CRT screen.

The data of the center horizontal graticule line is 128 ($(80)_{16}$ for the hexadecimal system). The data zero ($(00)_{16}$ for the hexadecimal system) corresponds to the position one division lower than the bottom graticule line. The data 255 ($(FF)_{16}$ for the hexadecimal system) is equal to the position one division higher than the top graticule line.

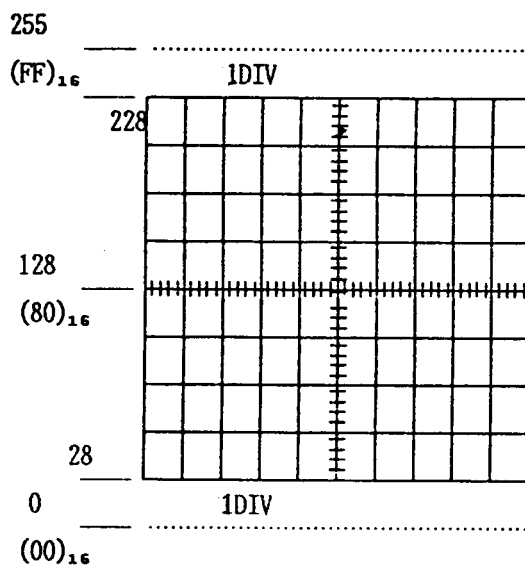

④ Transmission function of the measuring condition data

The instrument stores the data of the measuring conditions under which the data loaded in the memories was sampled. By the command from the personal computer, the measuring condition of a waveform in a certain memory can be transmitted.

Data is transmitted as a whole at a time of transfer. A specific data alone cannot be transmitted. The data format of the measuring conditions conforms to the ASCII system.

⑤ Reception function of the waveform data

The contents of the SAVE memory A and the SAVE memory B can be changed by the waveform data from the personal computer.

Set the RECALL switch to ON so that the rewritten data is displayed on the CRT.

⑥ Reception function of measuring condition data

The measuring condition data from the personal computer can be registered as the data for the waveform of the SAVE memory A or the SAVE memory B.

When the RECALL switch is turned to on, the data on VOLTS/DIV and TIME/DIV is displayed on the CRT.

⑦ Parameter calculation function

The following parameters can be calculated for any of the four memory waveform data CH1 acquisition memory, CH2 acquisition memory, SAVE A and SAVE B.

- a) Maximum value
- b) Minimum value
- c) Mean value

⑧ Transmission function of parameters

The calculated results of the above calculation can be transmitted.

(3) Transmitting and receiving format of measuring condition data

After the instrument receives the R0 command, the measuring condition data of the prescribed memory waveform is sent according to the following format.

For details of each item, refer to Table 10-5.

Also, when the instrument receives the W0 command, it receives and registers the data sent according to the following format as the measuring condition data of the prescribed SAVE memory.

#	i	@	,	V.M	,	H.M	,	A.T	,	B.T	,	V.0	,	P.F	,	V.D	,	D.T	,	N.S	,	S.C	DEL
---	---	---	---	-----	---	-----	---	-----	---	-----	---	-----	---	-----	---	-----	---	-----	---	-----	---	-----	-----

"i" indicates the memory number which is the same as "i" of the commands R0(i) and W0(i).

Do not add the sum check to the receiving format of the measuring condition data.

(4) Transmitting format of parameters

When the instrument receives the commands G1 to G3, the parameters of the waveform data of the prescribed memory is sent according to the following format.

o Maximum value

#	i	@	,	M	A	X	,	X	X	X	,	S.C	DEL
---	---	---	---	---	---	---	---	---	---	---	---	-----	-----

"i" is the memory number. The instrument transmits the parameters by adding the i data designated by the G1 (i) command.

XXX is the ASCII code data with the maximum value data of 3 digits in the decimal system.

o Minimum value

#	i	@	,	M	I	N	,	X	X	X	,	S.C	DEL
---	---	---	---	---	---	---	---	---	---	---	---	-----	-----

"i" is the memory number. The instrument transmits the parameters by adding the i data designated by the G2 (i) command.

XXX is the ASCII code data with the minimum value data of 3 digits in the decimal system.

o Mean value

#	i	@	,	A	V	R	,	X	X	X	,	S.C	DEL
---	---	---	---	---	---	---	---	---	---	---	---	-----	-----

"i" is the memory number. The instrument transmits the parameters by adding the i data designated by the G3 (i) command.

XXX is the ASCII code data with the mean value data of 3 digits in the decimal system.

The sum check (S.C) and the delimiter (DEL) are the same as the transmission of the measuring condition data. Refer to Table 10-5.

Table 10-3 Function Commands (1/4)

No.	Function	Commands	Contents	Transmitting format														
1	Sampling Norm single	S1 command	<ul style="list-style-type: none"> Performs the single operation under the measuring condition which is previously set, and orders the command to retain the waveform data on the display memory. 	<table border="1" style="margin-left: auto; margin-right: auto;"> <tr> <td style="padding: 2px;">S</td> <td style="padding: 2px;">1</td> <td style="padding: 2px;">DEL</td> </tr> </table>	S	1	DEL											
S	1	DEL																
2	Sweep range setting function	TM command	<ul style="list-style-type: none"> Designates the sweep range to do the above norm single or average single sampling. When the horizontal mode is at A or ALT: A TIME/DIV is set. When the horizontal mode is B: B TIME/DIV is set. A TIME/DIV \geq B TIME/DIV 	<table border="1" style="margin-left: auto; margin-right: auto;"> <tr> <td style="padding: 2px;">T</td> <td style="padding: 2px;">M</td> <td style="padding: 2px;">(</td> <td style="padding: 2px;">t</td> <td style="padding: 2px;">t</td> <td style="padding: 2px;">t</td> <td style="padding: 2px;">t</td> <td style="padding: 2px;">u</td> <td style="padding: 2px;">u</td> <td style="padding: 2px;">u</td> <td style="padding: 2px;">u</td> <td style="padding: 2px;">)</td> <td style="padding: 2px;">DEL</td> </tr> </table> <p style="margin-left: 40px;"> tttt: Time range values (One of 0.1, 0.2, 0.5, 1.0, 2.0, 5.0, 10.0, 20.0, 50.0) 2.5 for only VC-6045 uuuu: Unit (One of S, MS, MICS, NS) </p>	T	M	(t	t	t	t	u	u	u	u)	DEL	
T	M	(t	t	t	t	u	u	u	u)	DEL						
3	Waveform data trans- mission	Ri command	<ul style="list-style-type: none"> Designates the transfer of the waveform data stored in the Memory i by the data number (nnnn) with the address data (mmmm) at the head. Either the ASCII system or the binary system can be designated as the transmission method by X in the right column. The personal computer receives the prescribed data after transmitting this command. For the acquisition memory capacity, refer to Table 10-2. 	<table border="1" style="margin-left: auto; margin-right: auto;"> <tr> <td style="padding: 2px;">R</td> <td style="padding: 2px;">i</td> <td style="padding: 2px;">(</td> <td style="padding: 2px;">m</td> <td style="padding: 2px;">m</td> <td style="padding: 2px;">m</td> <td style="padding: 2px;">m</td> <td style="padding: 2px;">,</td> <td style="padding: 2px;">n</td> <td style="padding: 2px;">n</td> <td style="padding: 2px;">n</td> <td style="padding: 2px;">n</td> <td style="padding: 2px;">)</td> <td style="padding: 2px;">DEL</td> </tr> </table> <p style="margin-left: 40px;">"i" indicates the memory number.</p>	R	i	(m	m	m	m	,	n	n	n	n)	DEL
R	i	(m	m	m	m	,	n	n	n	n)	DEL					

Table 10-3 Function Commands (2/4)

No.	Function	Commands	Contents	Transmitting format														
				<table border="1" data-bbox="308 40 539 493"> <thead> <tr> <th>i</th> <th>Memory</th> </tr> </thead> <tbody> <tr> <td>1</td> <td>CH1 acquisition memory</td> </tr> <tr> <td>2</td> <td>CH2 acquisition memory</td> </tr> <tr> <td>3</td> <td>SAVE memory A</td> </tr> <tr> <td>4</td> <td>SAVE memory B</td> </tr> <tr> <td>5</td> <td>CH1 display memory</td> </tr> <tr> <td>6</td> <td>CH2 display memory</td> </tr> </tbody> </table> <p data-bbox="569 40 693 604">"mmmm": Leading address in memories Four-digit integer: 0-0999, 1999, 3999 (CH1 and CH2 acquisition memories) 0-0999 (Save memories, CH1 and CH2 display memories)</p> <p data-bbox="754 40 954 604">"nnnn": Number of transferred data Four-digit integer: 1-1000, 2000, 4000 (CH1 and CH2 acquisition memories) 1-1000 (Save memories, CH1 and CH2 display memories)</p> <p data-bbox="962 262 1024 604">x = A: ASCII system B: Binary system</p>	i	Memory	1	CH1 acquisition memory	2	CH2 acquisition memory	3	SAVE memory A	4	SAVE memory B	5	CH1 display memory	6	CH2 display memory
i	Memory																	
1	CH1 acquisition memory																	
2	CH2 acquisition memory																	
3	SAVE memory A																	
4	SAVE memory B																	
5	CH1 display memory																	
6	CH2 display memory																	
4	Transmission of measuring condition data	R0 command	<ul style="list-style-type: none"> o Designates the transfer of the measuring condition data at the time of sampling the waveform that Memory i stores. o The personal computer receives the prescribed data after transmitting this command. 	<table border="1" data-bbox="1078 181 1147 544"> <tr> <td>R</td> <td>0</td> <td>(</td> <td>i</td> <td>)</td> <td>DEL</td> </tr> </table> <p data-bbox="1185 60 1224 604">"i" (= 1 to 4) indicates the same</p>	R	0	(i)	DEL								
R	0	(i)	DEL													

Table 10-3 Function Commands (3/4)

No.	Function	Commands	Contents	Transmitting format																						
5	Receiving of waveform data	Wi command	<ul style="list-style-type: none"> o Transmits the waveform data from the personal computer to the instrument to designate the SAVE memory A and B to write the data in sequence beginning with the leading address mmmm. o The ASCII system or the binary system can be designated as the transmission method by X in the right column. o The personal computer transmits the waveform data after transmitting this command. 	<table border="1" style="margin-left: auto; margin-right: auto;"> <tr> <td>W</td><td>i</td><td>(</td><td>m</td><td>m</td><td>m</td><td>m</td><td>,</td><td>n</td><td>n</td><td>n</td><td>n</td><td>,</td><td>X</td><td>)</td><td>DEL</td> </tr> </table> <p>"i" indicates the memory number. "i" must be 3 or 4.</p> <table border="1" style="margin-left: auto; margin-right: auto;"> <tr> <td>i</td><td>Memory</td> </tr> <tr> <td>3</td><td>Save memory A</td> </tr> <tr> <td>4</td><td>Save memory B</td> </tr> </table> <p>"mmm": Leading address written in Four-digit integer: 0000 to 0999</p> <p>"nnnn": Number of transferred data Four-digit integer: 0001 to 1000</p> <p>X = A: ASCII system B: Binary system</p>	W	i	(m	m	m	m	,	n	n	n	n	,	X)	DEL	i	Memory	3	Save memory A	4	Save memory B
W	i	(m	m	m	m	,	n	n	n	n	,	X)	DEL											
i	Memory																									
3	Save memory A																									
4	Save memory B																									
6	Receiving of measuring condition data	W0 command	<ul style="list-style-type: none"> o Transmits the measuring condition from the personal computer to the instrument, and designates the instrument to register the measuring condition data of the waveform that the SAVE memory A or B stores. o The personal computer transmits the measuring condition data after transmitting this command. 	<table border="1" style="margin-left: auto; margin-right: auto;"> <tr> <td>W</td><td>0</td><td>(</td><td>i</td><td>)</td><td>DEL</td> </tr> </table> <p>"i" indicates the memory number, "i" must be 3 or 4.</p> <table border="1" style="margin-left: auto; margin-right: auto;"> <tr> <td>i</td><td>Memory</td> </tr> <tr> <td>3</td><td>Save memory A</td> </tr> <tr> <td>4</td><td>Save memory B</td> </tr> </table>	W	0	(i)	DEL	i	Memory	3	Save memory A	4	Save memory B										
W	0	(i)	DEL																					
i	Memory																									
3	Save memory A																									
4	Save memory B																									

Table 10-3 Function Command (4/4)

No.	Function	Commands	Contents	Transmitting format										
7	Parameter calculation The maximum value	E1 command	Designates the calculation of the maximum value of the waveform data that the memory i stores.	<table border="1" style="margin-left: auto; margin-right: auto;"> <tr> <td style="padding: 2px;">E</td> <td style="padding: 2px;">1</td> <td style="padding: 2px;">(</td> <td style="padding: 2px;">i</td> <td style="padding: 2px;">)</td> <td style="padding: 2px;">DEL</td> </tr> </table>	E	1	(i)	DEL				
E	1	(i)	DEL									
ii)	The minimum value	E2 command	Designates the calculation of the minimum value of the waveform data that the memory i stores.	<table border="1" style="margin-left: auto; margin-right: auto;"> <tr> <td style="padding: 2px;">E</td> <td style="padding: 2px;">2</td> <td style="padding: 2px;">(</td> <td style="padding: 2px;">i</td> <td style="padding: 2px;">)</td> <td style="padding: 2px;">DEL</td> </tr> </table>	E	2	(i)	DEL				
E	2	(i)	DEL									
iii)	The mean value	E3 command	Designates the calculation of the mean value of the waveform data that the memory i stores.	<table border="1" style="margin-left: auto; margin-right: auto;"> <tr> <td style="padding: 2px;">E</td> <td style="padding: 2px;">3</td> <td style="padding: 2px;">(</td> <td style="padding: 2px;">i</td> <td style="padding: 2px;">)</td> <td style="padding: 2px;">DEL</td> </tr> </table>	E	3	(i)	DEL				
E	3	(i)	DEL									
<p>"i" indicates the memory number.</p>														
				<table border="1" style="margin-left: auto; margin-right: auto;"> <tr> <td style="padding: 2px;">i</td> <td style="padding: 2px;">Memory</td> </tr> <tr> <td style="padding: 2px;">1</td> <td style="padding: 2px;">CH1 acquisition memory</td> </tr> <tr> <td style="padding: 2px;">2</td> <td style="padding: 2px;">CH2 acquisition memory</td> </tr> <tr> <td style="padding: 2px;">3</td> <td style="padding: 2px;">SAVE memory A</td> </tr> <tr> <td style="padding: 2px;">4</td> <td style="padding: 2px;">SAVE memory B</td> </tr> </table>	i	Memory	1	CH1 acquisition memory	2	CH2 acquisition memory	3	SAVE memory A	4	SAVE memory B
i	Memory													
1	CH1 acquisition memory													
2	CH2 acquisition memory													
3	SAVE memory A													
4	SAVE memory B													
8	Transmitting function of parameter													
i)	The Maximum value	G1 command	Designates the transmission of the maximum value calculated from the waveform data of Memory i.	<table border="1" style="margin-left: auto; margin-right: auto;"> <tr> <td style="padding: 2px;">G</td> <td style="padding: 2px;">1</td> <td style="padding: 2px;">(</td> <td style="padding: 2px;">i</td> <td style="padding: 2px;">)</td> <td style="padding: 2px;">DEL</td> </tr> </table>	G	1	(i)	DEL				
G	1	(i)	DEL									
ii)	The minimum value	G2 command	Designates the transmission of the minimum value calculated from the waveform data of Memory i.	<table border="1" style="margin-left: auto; margin-right: auto;"> <tr> <td style="padding: 2px;">G</td> <td style="padding: 2px;">2</td> <td style="padding: 2px;">(</td> <td style="padding: 2px;">i</td> <td style="padding: 2px;">)</td> <td style="padding: 2px;">DEL</td> </tr> </table>	G	2	(i)	DEL				
G	2	(i)	DEL									
iii)	The mean value	G3 command	Designates the transmission of the mean value calculated from the waveform data of Memory i.	<table border="1" style="margin-left: auto; margin-right: auto;"> <tr> <td style="padding: 2px;">G</td> <td style="padding: 2px;">3</td> <td style="padding: 2px;">(</td> <td style="padding: 2px;">i</td> <td style="padding: 2px;">)</td> <td style="padding: 2px;">DEL</td> </tr> </table>	G	3	(i)	DEL				
G	3	(i)	DEL									
<p>The waveform data must be calculated previously by the commands E1 to E3.</p>														
<p>The personal computer receives the prescribed data after transmitting this command.</p>														
				<p>"i" (=1 to 4) indicates the memory number as shown in item 7.</p>										

Table 10-4 Format of the Transmission
of the Waveform Data

No.	Item	Name	Format	ASCII system		Binary system	
				Data code	Bytes	Data code	Bytes
1	#i@	Memory number	"i" is 1 to 6 (NOTE 4)	ASCII	3	ASCII	3
2	mmmm	Leading address	Decimal, four digits 0000 to 999, 1999, 3999 (NOTE 5)	ASCII	4	ASCII	4
3	nnnn	Data number	Decimal, four digits 0001 to 1000, 2000, 4000 (NOTE 5)	ASCII	4	ASCII	4
4	Di	Data	o ASCII system Decimal, three digits/1 data 000 to 255 o Binary system 8-bit binary data	ASCII	3	Binary	1
5	S.C	Sum check (NOTE 1) (NOTE 2)	o ASCII system Hexadecimal ASCII data 00 to FF o Binary system 8-bit binary data	ASCII	2	Binary	1
6	DEL	Delim- iter	C/R L/F or C/R (NOTE 3)	ASCII	1 to 2	---	1 to 2

NOTE 1: The Sum check data adds all the former data (including symbols like a comma, etc.) by the binary system, and uses the least significant 8 bits of the data obtained as a result.

NOTE 2: Do not add S.C in the receiving mode.

NOTE 3: The format of a delimiter data is C/R L/F or C/R.
For the setting, refer to 9.4 (2).

NOTE 4: In the receiving mode, only 3 or 4 can be designated.

NOTE 5: For details, refer to Table 10-2.

Table 10-5 Transmitting and receiving format
of measuring condition data

No.	Item	Name	Format	Byte number (NOTE 3)	
				Transmitting	Receiving
1	#i@	Memory number	"i" is 1, 2, 3 or 4 (NOTE 4)	3	3
2	V.M	Vertical mode	One of CH1, CH2, CHOP (including dual trace mode), ADD (Right justify)	4	4
3	H.M	Horizontal mode	A (including ALT mode) or B	1	1
4	A.T	A TIME/DIV	A TIME range value: F3.1 (NOTE 1) Unit: S, MS, MICS (Right justify)	9	9
5	B.T	B TIME/DIV	B TIME range value: F3.1 (NOTE 1) Unit: S, MS or MICS (Right justify)	9	9
6	V.C	Volt CAL	CAL or UNCAL (Right justify)	5	5
7	P.F	Probe factor	P1X or P10X (Right justify)	4	4
8	V.D	Volts/DIV	VOLT range value: F3.1 (NOTE 1) Unit: V, MV (Right justify) (NOTE 2)	7	7
9	D.T	Delay amount	0.20 to 10.00 DIV: F4.2 (NOTE 1)	9	9
10	N.S	No. of sweeps	1, 4, 16 (NOTE 5)	3	3
11	S.C	Sum check	Hexadecimal ASCII data 00 to FF	2	0 (NOTE 6)
12	DEL	Delimiter	C/R L/F or C/R (NOTE 7)	1 to 2	1 to 2

- NOTE 1:** For example, F3.1 is indicated as 50.0.
A space symbol of over one word is placed between the value and the unit.
- NOTE 2:** When the VOLTS/DIV settings of CH1 and CH2 are different in the ADD mode, the data is transmitted with ADD only.
- NOTE 3:** "Transmitting" and "Receiving" are described, viewed from the instrument.
- NOTE 4:** In the receiving mode, only 3 or 4 can be designated.
- NOTE 5:** Setting of the number of average in the three modes, 1, 4 and 16 (1: NORM, 4: 4 times and 16: 16 times)
- NOTE 6:** Do not add a sum check data in the receiving mode.
- NOTE 7:** The format of a delimiter data is C/R L/F or C/R.
For the setting, refer to 9.4 (2).

10.7 Delimiter

For the transmission of the waveform data or the function command message, the controller sends a delimiter to indicate the end of data to the instrument.

The delimiter can select C/R L/F or C/R.

For the setting, refer to item 9.4 (2).

10.8 Processing of Abnormal Operation

The instrument sends the return code in order to respond to a message command, or to inform the personal computer of the status. The following is the format and the meaning of these status bytes.

No.	Status byte	Description
1	41	Processing for a command is completed normally.
2	61	Command error
3	62	Data error
4	63	Data content error
5	64	Excessive data number
6	65	Insufficient data number
7	67	Protocol error

The return codes of the command error are transmitted when there is a format error in the message command.

10.9 Connection of the RS-232C Interface Cable and the Activation of the Instrument

- (1) Connect the RS-232C cable between the instrument and the personal computer.
- (2) Set the communication mode of the instrument and the personal computer according to item 9.4 (2).
- (3) Set the instrument power to on, set the front panel controls and set the instrument in the HOLD mode. Now, the data transfer is possible. Perform the operation according to the commands from the personal computer.

10.10 Creation of Programs for Data Transfer

To facilitate programming, first execute a simple test program, send the function command to the instrument by the simple program, and check the resultant data received from the instrument. This simple test program will check the system validation and then a complete program can be written.

The following program statement depends on the employed personal computer. Before transmission, read carefully the employed personal computer manual, because the personal computer may require preparation such as data buffer area reservation and delimiter setting.

10.11 Major Causes of Abnormal Data Transfer

Check the below items when data transfer is not executed properly.

- (1) A cable is not connected or power of any equipment in the system is not turned on.
- (2) The instrument is not in the HOLD mode. Verify that the panel setting are as specified in item 10.5 (1).

- (3) The trigger mode is in the NORM trigger mode, and the trigger signal is not connected. (When the single sweep is executed by the S1 command from the personal computer.)
- (4) The function command does not correspond to that of the instrument.
- (5) The instrument does not correspond to the setting of the communication mode of the personal computer.
- (6) The format of delimiter does not correspond to that of the instrument.
- (7) The instrument is not initialized after the communication mode changes. When the instrument is turned on, the instrument reads the DIP switch settings and memorizes the data. Consequently, the communication mode can not be changed while the power is on.
- (8) The function with which the instrument is not provided is executed. (PPC, GET, TCT, etc.)
- (9) The buffer area of the data is not provided. (Transmission of a large amount of data is requested for the instrument though a listener has a small amount of buffer area.)
- (10) There is an error in program. Use of decimal and hexadecimal systems is not proper.

10.12 Programming Example

The following is an example of the programs executed when the instrument and the personal computer are connected. Prior to the connection with the personal computer, set the instrument, referring to the communication mode described in item 9.4 (2).

In this section, the GW-BASIC program of IBM.XT is used as an example for each function command.

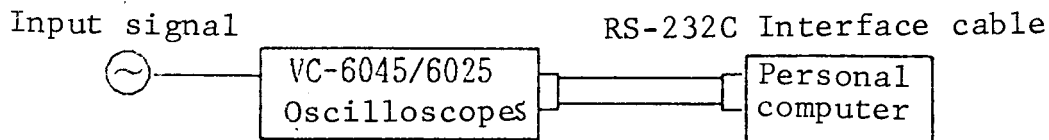

The following communication mode is used for the example of the above program.

- (a) Baud rate: 9600 baud
- (b) Data format: START BIT + 8 BIT + 1 STOP BIT
- (c) Delimiter: C/R

(1) Program example 1 "S1" command

The NORMAL SINGLE mode is activated by the "S1" command. This is a program for observing the operation until the sampling is completed.

The program example 1 is the program for the IBM XT (GW-BASIC).

Program example 1

```
10 ' *** S1 COMMAND (GW-BASIC) ***
20 OPEN "COM1:9600,N,8,1,CS,DS,CD" AS #1
30 PRINT #1,"S1"
40 LINE INPUT #1,RTN$
50 RTN=ASC(RTN$)
60 IF RTN<>&H41 THEN 110
70 ' *****
80 ' ** ANOTHER PROGRAM **
90 ' *****
100 GOTO 120
110 PRINT "ERROR STATUS=";HEX$(RTN)
120 CLOSE #1
130 END
```

' Comment
' RS-232C OPEN
' TM Command transmit
' Return code receive
'
' Return code check
' As the time range is set,
' another program can be
' executed.
'
' Return code display
' RS-232C CLOSE

(Explanation)

The instrument activates the sampling by "S1" command. When the sampling is completed, the return code inform that the operation is completed satisfactory. The lines from 40 to 60 observe the return code.

If the return code is 65 (41 for hexadecimal), the operation is completed with a satisfactory result and it is possible to proceed another program (e.g., a program to read a waveform data).

(2) Program example 2 "TM" command

This is a program for setting the time range to 5 ms/DIV by the "TM" command.

With this program, it is possible to know that the setting is completed normally (just like the program example 1).

The program example 2 is the program for the IBM XT (GW-BASIC.)

Program example 2

```
10 ' *** TM(tttt uuuu) COMMAND (GW-BASIC) *** ' Comment
20 OPEN "COM1:9600,N,8,1,CS,DS,CD" AS #1 ' RS-232C OPEN
30 PRINT #1,"TM(5.0 MS)" ' S1 Command transmit
40 LINE INPUT #1,RTN$ ' Return code receive
50 RTN=ASC(RTN$) '
60 IF RTN<>&H41 THEN 110 ' Return code check
70 ' ***** ' As the single sweep
80 ' ** ANOTHER PROGRAM ** ' finishes, another program
90 ' ***** ' can be executed.
100 GOTO 120 '
110 PRINT "ERROR STATUS=";HEX$(RTN) ' Return code display
120 CLOSE #1 ' RS-232C CLOSE
130 END '
```

(3) Program example 3 "Ri" command

This is a program to receive 50 words of the CH1 waveform data from the 0 address by the "Ri" command.

Program example 3-1: ASCII code transfer,
for IBM XT (GW-BASIC)

Program example 3-2: Binary code transfer,
for IBM XT (BW-BASIC)

Program example 3-1

```

10 ' *** Ri(mmmm, nnnn,x) COMMAND (GW-BASIC) *** ' Comment
20 OPEN "COM1:9600,N,8,1,CS,DS,CD" AS #1 ' RS-232C OPEN
30 PRINT #1,"R1(0000,0050,A)" ' Ri Command transmit
40 LINE INPUT #1,RTN$ ' Waveform data receive
50 PRINT "R1 RETURN=";RTN$ ' Waveform data display
60 CLOSE #1 ' RS-232C CLOSE
70 END

```

Program example 3-2

```

10 ' *** Ri(mmmm, nnnn,x) COMMAND (GW-BASIC) *** ' Comment
20 OPEN "COM1:9600,N,8,1,CS,DS,CD" AS #1 ' RS-232C OPEN
30 PRINT #1,"R1(0000,0050,B)" ' Ri Command transmit
40 RTN$=INPUT$(14,1) ' Waveform data receive
50 FOR I=1 TO 52 '
60     WRK$=INPUT$(1,1) '
70     RTN$=RTN$+MID$(STR$(ASC(WRK$)),2)+"," '
80 NEXT I '
90 PRINT "R1 RETURN=";RTN$ ' Waveform data display
100 CLOSE #1 ' RS-232C CLOSE
110 END '

```

(4) Program example 4 "R0" command

This is a program to receive the measuring condition data of CH1 by the "R0" command and display the data. The program example 4 is the program for the IBM-XT (GW-BASIC).

Program example 4

```

10 ' *** R0(i) COMMAND (GW-BASIC) *** ' Comment
20 OPEN "COM1:9600,N,8,1,CS,DS,CD" AS #1 ' RS-232C OPEN
30 PRINT #1,"R0(1)" ' R0 Command transmit
40 LINE INPUT #1,RTN$ ' CH1 setting condition receive
50 PRINT "R0 RETURN=";RTN$ ' Display
60 CLOSE #1 ' RS-232C CLOSE
70 END '

```

(5) Program example 5 "Wi" command

This is a program to write data in the save memory A by the "Wi" command. The lines 30 to 200 set the waveform data to be transmitted to the instrument to the letter variable A\$. Set the waveform data according to application. "Wi" command is transmitted by the line 220, and the waveform data set to A\$ is written in the save memory A by the lines 270 to 310. The waveform data from the 0 address to the 999 address is written in the save memory A as shown in Fig. 10-3.

Program example 5-1: ASCII code transfer,
for IBM XT (GW-BASIC)
Program example 5-2: Binary code transfer
for IBM XT (GW-BASIC)

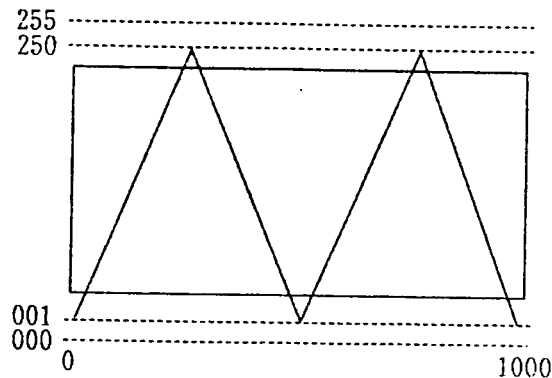

Fig. 10-3

Program example 5-1

```

10 ' *** Wi(mmmm,nnnn,x) COMMAND (GW-BASIC) ***      ' Comment
20 DIM A$(1000)                                       ' Set waveform data to the
30 CNT=0                                              ' character variable A$.
40 FOR I=1 TO 2                                       ' ( Set the triangle wave
50   FOR B=1 TO 250                                   ' (001-250,250-001) shown
60     IF B>=100 THEN B$=MID$(STR$(B),2,3)          ' in Fig.10-3 by the
70     IF B<100 THEN B$="0"+MID$(STR$(B),2,2)       ' 1000-word ASCII code. )
80     IF B<10 THEN B$="00"+MID$(STR$(B),2,1)
90     A$(B+CNT*250)=B$+", "
100  NEXT B
110  CNT=CNT+1
120  FOR B=1 TO 250
130    C=251-B
140    IF C>=100 THEN B$=MID$(STR$(C),2,3)
150    IF C<100 THEN B$="0"+MID$(STR$(C),2,2)
160    IF C<10 THEN B$="00"+MID$(STR$(C),2,1)
170    A$(B+CNT*250)=B$+", "
180  NEXT B
190  CNT=CNT+1
200 NEXT I
210 OPEN "COM1:9600,N,8,1,CS,DS,CD" AS #1           ' RS-232C OPEN
220 PRINT #1,"W3(0000,1000,A)"                     ' Wi Command transmit
230 LINE INPUT #1,RTN$                              ' Return code receive
240 RTN=ASC(RTN$)
250 IF RTN<>&H41 THEN 360                           ' Return code check
260   PRINT "Wi COMMAND PASS"
270 PRINT #1,"#3@,0000,1000, ";                    ' Waveform data transmit
280 FOR I=1 TO 999
290   PRINT #1,A$(I);
300 NEXT I
310 PRINT #1,A$(I)
320 LINE INPUT #1,RTN$                              ' Return code receive
330 RTN=ASC(RTN$)
340 IF RTN<>&H41 THEN 360                           ' Return code check
350 GOTO 370
360 PRINT "ERROR STATUS=";HEX$(RTN)
370 CLOSE #1                                         ' RS-232C CLOSE
380 END

```

Program example 5-2

```

10 ' *** Wi(mmmm,nnnn,x) COMMAND (GW-BASIC) *** ' Comment
20 DIM A$(1000) ' Set waveform data to the
30 CNT=0 ' character variable A$.
40 FOR I=1 TO 2 ' ( Set the binary data
50 FOR B=1 TO 250 ' of the triangle wave
60 B$=CHR$(B) ' shown in Fig.10-3. )
70 A$(B+CNT*250)=B$
80 NEXT B
90 CNT=CNT+1
100 FOR B=1 TO 250
110 C=251-B
120 B$=CHR$(C)
130 A$(B+CNT*250)=B$
140 NEXT B
150 CNT=CNT+1
160 NEXT I
170 OPEN "COM1:9600,N,8,1,CS,DS,CD" AS #1 ' RS-232C OPEN
180 PRINT #1,"W3(0000,1000,B)" ' Wi Command transmit
190 LINE INPUT #1,RTN$ ' Return code receive
200 RTN=ASC(RTN$)
210 IF RTN<>&H41 THEN 320 ' Return code check
220 PRINT "Wi COMMAND PASS"
230 PRINT #1,"#3@,0000,1000,"; ' Waveform data transmit
240 FOR I=1 TO 999
250 PRINT #1,A$(I);
260 NEXT I
270 PRINT #1,A$(I)
280 LINE INPUT #1,RTN$ ' Return code receive
290 RTN=ASC(RTN$)
300 IF RTN<>&H41 THEN 320 ' Return code check
310 GOTO 330
320 PRINT "ERROR STATUS=";HEX$(RTN)
330 CLOSE #1 ' RS-232C CLOSE
340 END

```

(6) Program example 6 "W0" command

This is a program to register the measuring condition data in the save memory A by the "W0" command.

The program example 6 is the program for the IBM XT (GW-BASIC).

Program example 6

```

10 ' *** W0(i) COMMAND (GW-BASIC) *** ' Comment
20 DAT$ = DAT$+"#3@," ' Set the setting condition data
30 DAT$ = DAT$+" CH1," ' registered to the character
40 DAT$ = DAT$+"A," ' variable DAT$.
50 DAT$ = DAT$+" 50.0 MS,"
60 DAT$ = DAT$+" 20.0 MS,"
70 DAT$ = DAT$+" CAL,"
80 DAT$ = DAT$+"P10X,"
90 DAT$ = DAT$+"50.0 MV,"
100 DAT$ = DAT$+"10.00 DIV,"
110 DAT$ = DAT$+" 1,"
120 OPEN "COM1:9600,N,8,1,CS,DS,CD" AS #1 ' RS-232C OPEN
130 PRINT #1,"W0(3)" ' W0 Command transmit
140 LINE INPUT #1,RTN$ ' Return code receive
150 RTN=ASC(RTN$)
160 IF RTN<>&H41 THEN 230 ' Return code check
170 PRINT "W0 COMMAND PASS"
180 PRINT #1,DAT$ ' Setting condition data transmit
190 LINE INPUT #1,RTN$ ' Return code receive
200 RTN=ASC(RTN$)
210 IF RTN<>&H41 THEN 230 ' Return code check
220 GOTO 240
230 PRINT "ERROR STATUS=";HEX$(RTN)
240 CLOSE #1 ' RS-232C CLOSE
250 END

```

- (7) Program example 7 "E1", "E2", "E3", "G1", "G2", and "G3" commands

Program 7-1 shows processes from the calculation of the maximum value to the reception and display of the maximum data.

The "E1" command is calculated by the line 30 and the calculation of the maximum value of CH1 is designated. The lines 40 to 60 are for the observation of the return code and the check that the calculation of the maximum value is completely normally. The lines 80 and 90 input the maximum data by the "G1" command. The program example 7-1 is the program for the program IBM XT (GW-BASIC).

Program example 7-1

```
10 ' *** E1(i) G1(i) COMMAND (GW-BASIC) ***      ' Comment
20 OPEN "COM1:9600,N,8,1,CS,DS,CD" AS #1        ' RS-232C OPEN
30 PRINT #1,"E1(1)"                             ' E1(i) Command transmit
40 LINE INPUT #1,RTN$                            ' Return code receive
50 RTN=ASC(RTN$)                                  '
60 IF RTN(>&H41 THEN 120                          ' Return code check
70 PRINT "E1 COMMAND PASS"                       '
80 PRINT #1,"G1(1)"                              ' G1(i) Command transmit
90 LINE INPUT #1,RTN$                            ' Maximum data receive
100 PRINT "MAX DATA=";RTN$                      ' Display
110 GOTO 130                                     '
120 PRINT "ERROR STATUS=";HEX$(RTN)             '
130 CLOSE #1                                     ' RS-232C CLOSE
140 END                                          '

```

The program example 7-2 shows a process from the calculation of the minimum value to the reception and display of the minimum data. The program example 7-2 is the program for the IBM XT (GW-BASIC)

Program 7-3 shows a process from the calculation of the mean value to the reception and display of the mean data. The program example 7-3 is the program for the IBM XT (GW-BASIC.)

The contents of the programs are the same as that of program example 7-1.

Program example 7-2

```

10 ' *** E2(i) G2(i) COMMAND (GW-BASIC) *** ' Comment
20 OPEN "COM1:9600,N,8,1,CS,DS,CD" AS #1 ' RS-232C OPEN
30 PRINT #1,"E2(1)" ' E2(i) Command transmit
40 LINE INPUT #1,RTN$ ' Return code receive
50 RTN=ASC(RTN$) '
60 IF RTN<>&H41 THEN 120 ' Return code check
70 PRINT "E2 COMMAND PASS" '
80 PRINT #1,"G2(1)" ' G2(i) Command transmit
90 LINE INPUT #1,RTN$ ' Minimum data receive
100 PRINT "MIN DATA=";RTN$ ' Display
110 GOTO 130 '
120 PRINT "ERROR STATUS=";HEX$(RTN) '
130 CLOSE #1 ' RS-232C CLOSE
140 END '

```

Program example 7-3

```

10 ' *** E3(i) G3(i) COMMAND (GW-BASIC) *** ' Comment
20 OPEN "COM1:9600,N,8,1,CS,DS,CD" AS #1 ' RS-232C OPEN
30 PRINT #1,"E3(1)" ' E3(i) Command transmit
40 LINE INPUT #1,RTN$ ' Return code receive
50 RTN=ASC(RTN$) '
60 IF RTN<>&H41 THEN 120 ' Return code check
70 PRINT "E3 COMMAND PASS" '
80 PRINT #1,"G3(1)" ' G3(i) Command transmit
90 LINE INPUT #1,RTN$ ' Average value data receive
100 PRINT "AVR DATA=";RTN$ ' Display
110 GOTO 130 '
120 PRINT "ERROR STATUS=";HEX$(RTN) '
130 CLOSE #1 ' RS-232C CLOSE
140 END '

```

The examples of the programs for function commands are illustrated above. It is recommended to create your own programs, using the above programs, according to the specific system application.

11. SPECIFICATIONS

The following specifications are applicable to the VC-6025, and VC-6045 oscilloscopes unless otherwise noted.

o CRT

Graticule: 6-inch, with internal graticule
0%, 10%, 90% and 100% markers
8 x 10 DIV (1 DIV = 1cm)

Phosphor: P31

Accelerating potential: 17 kV approx.
(12 kV approx. for the VC-6025)

External intensity modulation: Coupling: DC coupling
Voltage: 5 V or more
Maximum input voltage:
30 V (DC+AC peak) or 30 Vp-p AC at
1 kHz or less
Bandwidth: DC to 5 MHz

o VERTICAL DEFLECTION SYSTEM

Sensitivity: 2 mV/DIV to 5 V/DIV $\pm 3\%$
(switchable in 11 steps)
Continuously variable

Bandwidth: DC to 100 MHz -3dB
(DC to 50 Hz -3dB for the VC-6025)
2 mV/DIV : DC to 20 MHz -3dB
(DC to 10 MHz -3 dB for the VC-6025)
AC low pass : 10 Hz -3 dB

Rise time: 3.5 ns approx.
(5.9 ns approx. for the VC-6025)
2 mV/DIV : 17.5 ns approx.
(35 ns approx. for the VC-6025)

Delay time: Leading edge can be monitored

Maximum input voltage: 400 V (DC+AC peak) at 1 kHz or less
 Input coupling: AC, DC, GND
 Input impedance: 1 M Ω \pm 1.5%, 23 pF \pm 3 pF
 Display modes: CH1, CH2, DUAL, CHOP
 (250 kHz approx.),
 ADD (DIFF mode can be established when the CH2 is in the INVERT mode.)

 Bandwidth limiting function: 20 MHz (10 kHz for the VC-6025)
 Polarity selection +, - (CH2 only)
 Common-mode rejection ratio: 20 dB minimum at 20 MHz
 X-Y operation: REAL TIME mode: X-axis,
 Y-axis selectable
 STORAGE mode: X-axis = CH1
 Y-axis = CH2

 Sensitivity: X axis: CH1, CH2 2 mV to 5 V/DIV \pm 5%
 EXT 0.1 V/DIV \pm 5%
 EXT \times 10 1 V/DIV \pm 5%
 Y axis: 2 mV to 5 V/DIV \pm 3%
 Phase error: 3 $^{\circ}$ or less from DC to 50 kHz
 X bandwidth: DC to 500 kHz (-3 dB)

o HORIZONTAL DEFLECTION SYSTEM

Sweep time
 * REAL TIME mode
 A(main) sweep: 50 ns/DIV to 0.5 s/DIV
 Continuously variable (UNCAL)
 B(delay) sweep 50 ns/DIV to 50 ms/DIV
 * STORAGE mode
 A(main) sweep: 50 ns/DIV to 50 s/DIV
 50 ns/DIV to 2 μ s/DIV available only for a repetitive waveform
 0.2 s/DIV to 50 s/DIV only for ROLL mode

B(delay) sweep: 2.5 μ s/DIV to 50 ms/DIV
 (5 μ s/DIV to 50 ms/DIV for the VC-6025)
 Accuracy: X1: \pm 3%, X10 MAG: \pm 4%
 Holdoff time: Variable
 Delay time: 1 μ s to 5s
 Delay jitter: 1/20,000 or less
 Sweep magnification: X10
 Maximum sweep rate: 5 ns/DIV
 Alternate separation: Variable (REAL TIME only)
 Trigger lock function: Provided
 Auto range function: Provided

o TRIGGERING

Trigger mode: Trigger, auto trigger
 Trigger source: CH1, CH2, EXT (AC,DC,DC \pm 10), LINE
 TV trigger: Exclusive sync separator circuit
 provided
 Sensitivity: SYNC signal
 INT: 1 DIV or more
 EXT: 200 mVp-p or more

Trigger
 sensitivity:

NORM mode:

Frequency	DC to 20 MHz	20 to 100 MHz (20 to 50 MHz for the VC-6025)
INT	0.35 DIV	1.5 DIV
EXT	50 mV	150 mV

AUTO mode:

Frequency	30 to 100 Hz	100 Hz to 20 MHz	20 to 100 MHz (20 to 50 MHz for the VC-6025)
INT	1.5 DIV	1 DIV	1.5 DIV
EXT	150 mV	100 mV	150 mV

Trigger level
 variable range: AUTO: Automatically corresponds to
 the trigger signal
 NORM:
 INT: ± 4 DIV or more
 EXT: ± 0.4 V or more
 EXT $\times 10$: ± 4 V or more
 Slope: +, -
 External input: Impedance: 1 M Ω $\pm 5\%$, 25pF ± 6 pF
 Voltage: 400 V (DC+AC peak) at 1 kHz

o READOUT FUNCTION

Panel setting
 display: Vertical axis: V/DIV, UNCAL,
 probe conversion
 Sweep speed: S/DIV, UNCAL, MAG
 (converted value)
 Other: Delay time, X-Y, TRIGGER,
 No. of averaging

o CURSOR READOUT

Function: Voltage difference ΔV : Δ -REF
 Time difference ΔT : Δ -REF
 Frequency $1/\Delta T$: Δ -REF

o EXTERNAL OUTPUT

Trigger signal out: Output voltage : 25 mV/DIV approx.
 (Full scale on the CRT)
 50-ohm termination
 Frequency response: DC to 10 MHz
 (-3 dB)
 Output impedance : 50 ohms approx.

o CALIBRATOR

Waveform: 1 kHz \pm 20%, square wave
Voltage: 0.5 V \pm 1%

DIGITAL STORAGE FUNCTIONS

o WAVEFORM DATA STORAGE

Memory capacity

Display memory: 1000 words x 4

Save memory: 1000 words x 2

Acquisition

memory: Single trace 2.5 μ s/DIV to 50 s/DIV
--- 4000 words
(5 μ s/DIV to 50 s/DIV
--- 2000 words for
the VC-6025)
Single trace 50 ns/DIV to 2 μ s/DIV
--- 1000 words
Dual trace 2.5 μ s/DIV to 50 s/DIV
--- 2000 words/CH
Dual trace 50 ns/DIV to 2 μ s/DIV
--- 1000 words/CH

Vertical resolution: 8 bits/10 DIV

Horizontal resolution: 100 data/DIV

Maximum sampling rate:

VC-6045: 40 Msps, one-channel sampling
40 Msps, two-channel alternate
sampling

VC-6025: 20 Msps, two-channel alternate
sampling

Sampling rate depends on the time range.

Maximum storage frequency

A single-shot signal

(Maximum amplitude

error: 30% or less): 5 MHz

A repetitive signal

VC-6045: 100 MHz (20 MHz at 2 mV/DIV)

VC-6025: 50 MHz (10 MHz at 2 mV/DIV)

o DATA ACQUISITION

NORM storage mode: Updates a picture on the CRT at each triggering.

AVG mode: Averages input signals by the selected number of average and displays the result after the averaging has reached the selected number.

(Number of average: 4 or 16)

ROLL mode: Shifts data from right to left continuously on the CRT. (The updating point is the right end.)

HOLD mode: Holds the waveform displayed on the CRT.

SINGLE sweep: Performs an operation of the NORM storage, or AVG mode once at each pressing the SINGLE RESET switch in the HOLD mode, and updates a picture.

o DATA SAVE: Up to two waveforms can be saved. Two stored waveforms can be displayed with the two sampling waveforms.

o PRETRIGGER: Variable (in 0.1 DIV steps)

o PLOTTER OUTPUT: Hard copy is available by the HP-GL through RS-232C. 6 colors are switchable.

o EXT INPUT: Provided with the RS-232C interface as standard.

o MAGNIFYING DISPLAY: A storage waveform can be magnified up to 10 times in the horizontal direction.

o MEMORY BACK-UP: Only a save memory can be backed up for approx. 48 hours.

o POWER SUPPLY

Voltage: 90 V to 250 V AC

Frequency: 48 to 440 Hz

Power consumption: 50 W approx.

o ENVIRONMENT

Operating temperature: 0 to 40 °C

Operating humidity: 45 to 85%

Specification guaranteed temperature: 10 to 35°C

Safe storage temperature: -20 to +70°C

Safe storage humidity: 35 to 85% (70% or less in the ambient temperature of 50°C)

o DIMENSIONS AND WEIGHT

Dimensions: 275(W) x 130(H) x 360(D) mm approx.
(10.8(W) x 5.1(H) x 14.2(D) in. approx.)

Weight: 7 kg approx. (15.4 lb. approx.)

HOW TO PHOTOGRAPH THE WAVEFORM

When photographing the scale

Since the oscilloscope is not provided with the scale illumination, the scale cannot be photographed in the normal state. To photograph the scale, perform either of the following methods.

<Raster method>

Connect a 50 kHz sine wave, and set the amplitude of the signal to 8 div on the screen. Set the A TIME/DIV switch to 1 ms and the TRIGGER MODE switch to AUTO. Then the entire screen becomes bright.

<Trace method>

Set the VERTICAL MODE switch to DUAL, the TRIGGER MODE switch to AUTO, and the A TIME/DIV switch to 0.1 ms so that two traces appear.

Increase the brightness of the traces by the INTEN control, and move the two traces to the outside of the screen. Thus the entire screen is brighter than the normal state.

Under the condition that the brightness of the entire screen is increased and the readout display is blanked by the above raster or trace method, photograph the screen first.

Then, display the waveform to be photographed, and photograph the waveform on the same frame with the readout display.

NOTES:

- (a) The scale is photographed in black.
- (b) When performing the double exposure, fix a camera at the same position to avoid the displacement of the scale and the waveform.